

Test Report

No. SHAEC1929071101

Date: 17 Jan 2020

Page 1 of 38

SHANGHAI HUAHONG GRACE SEMICONDUCTOR MANUFACTURING CORPORATION
288 HALEI ROAD, ZHANGJIANG HI-TECH PARK, SHANGHAI, P.R.CHINA

The following sample(s) was/were submitted and identified on behalf of the clients as : HHGRACE ALUMINUM PROCESS FINISHED 8 INCH WAFER-CMOS Without Co

SGS Job No. : SP19-042950 - SH
Date of Sample Received : 31 Dec 2019
Testing Period : 31 Dec 2019 - 09 Jan 2020
Test Requested : Selected test(s) as requested by client.
Test Method : Please refer to next page(s).
Test Results : Please refer to next page(s).
Conclusion : Based on the performed tests on submitted sample(s), the results of Cadmium, Lead, Mercury, Hexavalent chromium, Polybrominated biphenyls (PBBs), Polybrominated diphenyl ethers (PBDEs) and Phthalates such as Bis(2-ethylhexyl) phthalate (DEHP), Butyl benzyl phthalate (BBP), Dibutyl phthalate (DBP) and Diisobutyl phthalate (DIBP) comply with the limits as set by RoHS Directive (EU) 2015/863 amending Annex II to Directive 2011/65/EU.

Signed for and on behalf of
SGS-CSTC Standards Technical Services (Shanghai) Co., Ltd.

Dora Hu

Dora Hu
Approved Signatory



Unless otherwise agreed in writing, this document is issued by the Company subject to its General Conditions of Service printed overleaf, available on request or accessible at <http://www.sgs.com/en/Terms-and-Conditions.aspx> and, for electronic format documents, subject to Terms and Conditions for Electronic Documents at <http://www.sgs.com/en/Terms-and-Conditions/Terms-e-Document.aspx>. Attention is drawn to the limitation of liability, indemnification and jurisdiction issues defined therein. Any holder of this document is advised that information contained hereon reflects the Company's findings at the time of its intervention only and within the limits of Client's instructions, if any. The Company's sole responsibility is to its Client and this document does not exonerate parties to a transaction from exercising all their rights and obligations under the transaction documents. This document cannot be reproduced except in full, without prior written approval of the Company. Any unauthorized alteration, forgery or falsification of the content or appearance of this document is unlawful and offenders may be prosecuted to the fullest extent of the law. Unless otherwise stated the results shown in this test report refer only to the sample(s) tested.

Attention: To check the authenticity of testing /inspection report & certificate, please contact us at telephone: (86-755) 8307 1443, or email: CN.Doccheck@sgs.com

SGS-CSTC Standards Technical Services (Shanghai) Co., Ltd.
Testing Center - China Headquarter

13th Building, No. 889 Yishan Road Xuhui District, Shanghai China 200233
中国·上海·徐汇区宜山路889号3号楼 邮编: 200233

t E&E (86-21) 61402553 f E&E (86-21) 64953679 www.sgsgroup.com.cn
t HL (86-21) 61402594 f HL (86-21) 61156899 e sgs.china@sgs.com

Test Results :

Test Part Description :

Specimen No.	SGS Sample ID	Description
SN1	SHA19-290711.001	Colorful silicon wafer

Remarks :

- (1) 1 mg/kg = 0.0001%
- (2) MDL = Method Detection Limit
- (3) ND = Not Detected (< MDL)
- (4) "-" = Not Regulated

RoHS Directive (EU) 2015/863 amending Annex II to Directive 2011/65/EU

Test Method : With reference to IEC 62321-4:2013+AMD1:2017, IEC62321-5:2013, IEC62321-7-2:2017, IEC 62321-6:2015 and IEC62321-8:2017, analyzed by ICP-OES, AAS, UV-Vis and GC-MS.

Test Item(s)	Limit	Unit	MDL	001
Cadmium (Cd)	100	mg/kg	2	ND
Lead (Pb)	1000	mg/kg	2	ND
Mercury (Hg)	1000	mg/kg	2	ND
Hexavalent Chromium (Cr(VI))	1000	mg/kg	8	ND
Sum of PBBs	1000	mg/kg	-	ND
Monobromobiphenyl	-	mg/kg	5	ND
Dibromobiphenyl	-	mg/kg	5	ND
Tribromobiphenyl	-	mg/kg	5	ND
Tetrabromobiphenyl	-	mg/kg	5	ND
Pentabromobiphenyl	-	mg/kg	5	ND
Hexabromobiphenyl	-	mg/kg	5	ND
Heptabromobiphenyl	-	mg/kg	5	ND
Octabromobiphenyl	-	mg/kg	5	ND
Nonabromobiphenyl	-	mg/kg	5	ND
Decabromobiphenyl	-	mg/kg	5	ND
Sum of PBDEs	1000	mg/kg	-	ND
Monobromodiphenyl ether	-	mg/kg	5	ND
Dibromodiphenyl ether	-	mg/kg	5	ND
Tribromodiphenyl ether	-	mg/kg	5	ND
Tetrabromodiphenyl ether	-	mg/kg	5	ND



Unless otherwise agreed in writing, this document is issued by the Company subject to its General Conditions of Service printed overleaf, available on request or accessible at <http://www.sgs.com/en/Terms-and-Conditions.aspx> and, for electronic format documents, subject to Terms and Conditions for Electronic Documents at <http://www.sgs.com/en/Terms-and-Conditions/Terms-e-Documents.aspx>. Attention is drawn to the limitation of liability, indemnification and jurisdiction issues defined therein. Any holder of this document is advised that information contained hereon reflects the Company's findings at the time of its intervention only and within the limits of Client's instructions, if any. The Company's sole responsibility is to its Client and this document does not exonerate parties to a transaction from exercising all their rights and obligations under the transaction documents. This document cannot be reproduced except in full, without prior written approval of the Company. Any unauthorized alteration, forgery or falsification of the content or appearance of this document is unlawful and offenders may be prosecuted to the fullest extent of the law. Unless otherwise stated the results shown in this test report refer only to the sample(s) tested.

Attention: To check the authenticity of testing / inspection report & certificate, please contact us at telephone: (86-755) 8307 1443, or email: CN.Doccheck@sgs.com
 13th Building, No.889 Yishan Road Xuhui District, Shanghai China 200233 tE&E (86-21) 61402553 fE&E (86-21)64953679 www.sgs.com.cn
 中国·上海·徐汇区宜山路889号3号楼 邮编: 200233 tHL (86-21) 61402594 fHL (86-21) 61156899 e sgs.china@sgs.com

Test Report

No. SHAEC1929071101

Date: 17 Jan 2020

Page 3 of 38

<u>Test Item(s)</u>	<u>Limit</u>	<u>Unit</u>	<u>MDL</u>	<u>001</u>
Pentabromodiphenyl ether	-	mg/kg	5	ND
Hexabromodiphenyl ether	-	mg/kg	5	ND
Heptabromodiphenyl ether	-	mg/kg	5	ND
Octabromodiphenyl ether	-	mg/kg	5	ND
Nonabromodiphenyl ether	-	mg/kg	5	ND
Decabromodiphenyl ether	-	mg/kg	5	ND
Di-butyl Phthalate (DBP)	1000	mg/kg	50	ND
Benzyl Butyl Phthalate (BBP)	1000	mg/kg	50	ND
Di-2-Ethyl Hexyl Phthalate (DEHP)	1000	mg/kg	50	ND
Diisobutyl Phthalates (DIBP)	1000	mg/kg	50	ND

Notes :

- (1) The maximum permissible limit is quoted from RoHS Directive (EU) 2015/863. IEC 62321 series is equivalent to EN 62321 series
https://www.cenelec.eu/dyn/www/f?p=104:30:1742232870351101:::FSP_ORG_ID,FSP_LANG_ID:1258637,25
- (2) The restriction of DEHP, BBP, DBP and DIBP shall apply to medical devices, including in vitro medical devices, and monitoring and control instruments, including industrial monitoring and control instruments, from 22 July 2021.
- (3) The restriction of DEHP, BBP, DBP and DIBP shall not apply to toys which are already subject to the restriction of DEHP, BBP, DBP and DIBP through entry 51 of Annex XVII to Regulation (EC) No 1907/2006.

Halogen

Test Method : With reference to EN 14582: 2016 , analysis was performed by IC.

<u>Test Item(s)</u>	<u>Unit</u>	<u>MDL</u>	<u>001</u>
Chlorine (Cl)	mg/kg	50	ND
Bromine (Br)	mg/kg	50	ND
Fluorine (F)	mg/kg	50	ND
Iodine (I)	mg/kg	50	ND

Element(s)

Test Method : SGS in house method (SHTC- CHEM- SOP -50-T), analysis was performed by ICP-OES.



Unless otherwise agreed in writing, this document is issued by the Company subject to its General Conditions of Service printed overleaf, available on request or accessible at <http://www.sgs.com/en/Terms-and-Conditions.aspx> and, for electronic format documents, subject to Terms and Conditions for Electronic Documents at <http://www.sgs.com/en/Terms-and-Conditions/Terms-e-Document.aspx>. Attention is drawn to the limitation of liability, indemnification and jurisdiction issues defined therein. Any holder of this document is advised that information contained hereon reflects the Company's findings at the time of its intervention only and within the limits of Client's instructions, if any. The Company's sole responsibility is to its Client and this document does not exonerate parties to a transaction from exercising all their rights and obligations under the transaction documents. This document cannot be reproduced except in full, without prior written approval of the Company. Any unauthorized alteration, forgery or falsification of the content or appearance of this document is unlawful and offenders may be prosecuted to the fullest extent of the law. Unless otherwise stated the results shown in this test report refer only to the sample(s) tested.

Attention: To check the authenticity of testing / inspection report & certificate, please contact us at telephone: (86-755) 8307 1443, or email: CN.Doccheck@sgs.com

SGS-CSTC Shanghai Technical Services (Shanghai) Co., Ltd.
 Testing Center-Chemical Laboratory

3rd Building, No. 889 Yishan Road Xuhui District, Shanghai China 200233 t E&E (86-21) 61402553 f E&E (86-21) 64953679 www.sgs.com.cn
 中国·上海·徐汇区宜山路889号3号楼 邮编: 200233 t HL (86-21) 61402594 f HL (86-21) 61156899 e sgs.china@sgs.com

Test Report

No. SHAEC1929071101

Date: 17 Jan 2020

Page 4 of 38

<u>Test Item(s)</u>	<u>Unit</u>	<u>MDL</u>	<u>001</u>
Beryllium (Be)	mg/kg	5	ND
Beryllium oxide (BeO) ♦	mg/kg	15	ND
Antimony trioxide (Sb ₂ O ₃) ♦	mg/kg	12	ND

Notes :

- (1) ♦BeO: Calculate from Beryllium content.
 ♦Sb₂O₃: Calculate from Antimony content.

Cobalt dichloride

Test Method : SGS in house method (SHTC- CHEM- SOP -50-T&SHTC-CHEM-SOP-19-T), analysis was performed by IC and ICP-OES.

<u>Test Item(s)</u>	<u>Unit</u>	<u>MDL</u>	<u>001</u>
Cobalt Dichloride (CoCl ₂)♦	mg/kg	100	ND

Notes :

- (1) ♦Results of cobalt dichloride are calculated based on the results of cobalt and chloride.

Polychlorinated Naphthalenes (PCNs)

Test Method : With reference to US EPA 8081B: 2007, analysis was performed by GC-MS

<u>Test Item(s)</u>	<u>Unit</u>	<u>MDL</u>	<u>001</u>
1-Chlorinated Naphthalene	mg/kg	5	ND
2-Chlorinated Naphthalene	mg/kg	5	ND
1,4-Dichlorinated Naphthalene	mg/kg	5	ND
1,5-Dichlorinated Naphthalene	mg/kg	5	ND
1,2-Dichlorinated Naphthalene	mg/kg	5	ND
1,8-Dichlorinated Naphthalene	mg/kg	5	ND
1,2,3-Trichlorinated Naphthalene	mg/kg	5	ND
1,2,3,4-Tetrachlorinated Naphthalene	mg/kg	5	ND
1,2,3,4,6-Pentachlorinated Naphthalene	mg/kg	5	ND
Octa-chlorinated Naphthalene	mg/kg	5	ND

Perchlorate



Unless otherwise agreed in writing, this document is issued by the Company subject to its General Conditions of Service printed overleaf, available on request or accessible at <http://www.sgs.com/en/Terms-and-Conditions.aspx> and, for electronic format documents, subject to Terms and Conditions for Electronic Documents at <http://www.sgs.com/en/Terms-and-Conditions/Terms-e-Document.aspx>. Attention is drawn to the limitation of liability, indemnification and jurisdiction issues defined therein. Any holder of this document is advised that information contained hereon reflects the Company's findings at the time of its intervention only and within the limits of Client's instructions, if any. The Company's sole responsibility is to its Client and this document does not exonerate parties to a transaction from exercising all their rights and obligations under the transaction documents. This document cannot be reproduced except in full, without prior written approval of the Company. Any unauthorized alteration, forgery or falsification of the content or appearance of this document is unlawful and offenders may be prosecuted to the fullest extent of the law. Unless otherwise stated the results shown in this test report refer only to the sample(s) tested.

Attention: To check the authenticity of testing /inspection report & certificate, please contact us at telephone: (86-755) 8307 1443, or email: CN.Doccheck@sgs.com

SGS-CSTC (Shanghai) Technical Services (Shanghai) Co., Ltd.
 Testing Center - Chemical Laboratory

3rd Building, No. 889 Yishan Road Xuhui District, Shanghai China 200233 t E&E (86-21) 61402553 f E&E (86-21) 64953679 www.sgs.com.cn
 中国·上海·徐汇区宜山路889号3号楼 邮编: 200233 t HL (86-21) 61402594 f HL (86-21) 61156899 e sgs.china@sgs.com

Test Report

No. SHAEC1929071101

Date: 17 Jan 2020

Page 5 of 38

Test Method : SGS in house method (SHTC-CHEM-SOP-832-T), analysis was performed by LC-MS-MS.

<u>Test Item(s)</u>	<u>Unit</u>	<u>MDL</u>	<u>001</u>
Perchlorate	µg/kg	5	ND

Ozone Depleting Substances (ODS)

Test Method : With reference to US EPA 5021A:2014, analysis was performed by HS-GC-MS.

<u>Test Item(s)</u>	<u>CAS NO.</u>	<u>Unit</u>	<u>MDL</u>	<u>001</u>
CFC				
CFC-11	75-69-4	µg/g	0.1	ND
CFC-12	75-71-8	µg/g	0.1	ND
CFC-113	76-13-1	µg/g	0.1	ND
CFC-114	76-14-2	µg/g	0.1	ND
CFC-13	75-72-9	µg/g	0.1	ND
CFC-111	354-56-3	µg/g	0.1	ND
CFC-112	76-12-0	µg/g	0.1	ND
CFC-112	76-11-9	µg/g	0.1	ND
CFC-113	354-58-5	µg/g	0.1	ND
CFC-114	374-07-2	µg/g	0.1	ND
CFC-115	76-15-3	µg/g	0.1	ND
CFC-211	422-78-6	µg/g	0.1	ND
CFC-212	661-96-1	µg/g	0.1	ND
CFC-213	1652-89-7	µg/g	0.1	ND
CFC-214	677-68-9	µg/g	0.1	ND
CFC-215	1599-41-3	µg/g	0.1	ND
CFC-215	76-17-5	µg/g	0.1	ND
CFC-216	1652-80-8	µg/g	0.1	ND
CFC-216	661-97-2	µg/g	0.1	ND
CFC-217	422-86-6	µg/g	0.1	ND
Halon				
Halon 1211	353-59-3	µg/g	0.1	ND
Halon 1301	75-63-8	µg/g	0.1	ND
Halon 2402	124-73-2	µg/g	0.1	ND
HFC				
HFC-23	75-46-7	µg/g	0.1	ND
HFC-32	75-10-5	µg/g	0.1	ND



Unless otherwise agreed in writing, this document is issued by the Company subject to its General Conditions of Service printed overleaf, available on request or accessible at <http://www.sgs.com/en/Terms-and-Conditions.aspx> and, for electronic format documents, subject to Terms and Conditions for Electronic Documents at <http://www.sgs.com/en/Terms-and-Conditions/Terms-e-Documents.aspx>. Attention is drawn to the limitation of liability, indemnification and jurisdiction issues defined therein. Any holder of this document is advised that information contained hereon reflects the Company's findings at the time of its intervention only and within the limits of Client's instructions, if any. The Company's sole responsibility is to its Client and this document does not exonerate parties to a transaction from exercising all their rights and obligations under the transaction documents. This document cannot be reproduced except in full, without prior written approval of the Company. Any unauthorized alteration, forgery or falsification of the content or appearance of this document is unlawful and offenders may be prosecuted to the fullest extent of the law. Unless otherwise stated the results shown in this test report refer only to the sample(s) tested.

Attention: To check the authenticity of testing / inspection report & certificate, please contact us at telephone: (86-755) 8307 1443, or email: CN.Doccheck@sgs.com

SGS-CSTC Shanghai Technical Services Co., Ltd.
Testing Center - Chemical Laboratory

13th Building, No. 889 Yishan Road Xuhui District, Shanghai China 200233

t E&E (86-21) 61402553 f E&E (86-21) 64953679

www.sgsgroup.com.cn

中国·上海·徐汇区宜山路889号3号楼 邮编: 200233

t HL (86-21) 61402594

f HL (86-21) 61156899

e sgs.china@sgs.com

Test Report

No. SHAEC1929071101

Date: 17 Jan 2020

Page 6 of 38

<u>Test Item(s)</u>	<u>CAS NO.</u>	<u>Unit</u>	<u>MDL</u>	<u>001</u>
HFC-41	593-53-3	µg/g	0.1	ND
HFC-43-10mee		µg/g	0.1	ND
HFC-125	354-33-6	µg/g	0.1	ND
HFC-134	359-35-3	µg/g	0.1	ND
HFC-134a	811-97-2	µg/g	0.1	ND
HFC-152a	75-37-6	µg/g	0.1	ND
HFC-143	420-46-2	µg/g	0.1	ND
HFC-143a	430-66-0	µg/g	0.1	ND
HFC-227ea		µg/g	0.1	ND
HFC-236cb		µg/g	0.1	ND
HFC-236ea	431-63-0	µg/g	0.1	ND
HFC-236fa	690-39-1	µg/g	0.1	ND
HFC-245ca	679-86-7	µg/g	0.1	ND
HFC-245fa		µg/g	0.1	ND
HFC-365mfc		µg/g	0.1	ND
PFC				
Perfluoromethane	75-73-0	µg/g	0.1	ND
Perfluoroethane	76-16-4	µg/g	0.1	ND
Perfluoropropane	76-19-7	µg/g	0.1	ND
Perfluorobutane	355-25-9	µg/g	0.1	ND
Perfluoropentane	678-26-2	µg/g	0.1	ND
Perfluorohexane	355-42-0	µg/g	0.1	ND
Perfluorocyclobutane	115-25-3	µg/g	0.1	ND
CHC				
Carbon tetrachloride	56-23-5	µg/g	0.1	ND
1,1,1-trichloroethane	71-55-6	µg/g	0.1	ND
Others				
Sulphur Hexafluoride - SF ₆	2551-62-4	µg/g	0.1	ND

HCFC

Test Method : With reference to US EPA 5021A:2014, analysis was performed by HS-GC-MS.

<u>Test Item(s)</u>	<u>CAS NO.</u>	<u>Unit</u>	<u>MDL</u>	<u>001</u>
HCFC				
HCFC-21	75-43-4	µg/g	0.1	ND
HCFC-22	75-45-6	µg/g	0.1	ND
HCFC-31	593-70-4	µg/g	0.1	ND



Unless otherwise agreed in writing, this document is issued by the Company subject to its General Conditions of Service printed overleaf, available on request or accessible at <http://www.sgs.com/en/Terms-and-Conditions.aspx> and, for electronic format documents, subject to Terms and Conditions for Electronic Documents at <http://www.sgs.com/en/Terms-and-Conditions/Terms-e-Document.aspx>. Attention is drawn to the limitation of liability, indemnification and jurisdiction issues defined therein. Any holder of this document is advised that information contained hereon reflects the Company's findings at the time of its intervention only and within the limits of Client's instructions, if any. The Company's sole responsibility is to its Client and this document does not exonerate parties to a transaction from exercising all their rights and obligations under the transaction documents. This document cannot be reproduced except in full, without prior written approval of the Company. Any unauthorized alteration, forgery or falsification of the content or appearance of this document is unlawful and offenders may be prosecuted to the fullest extent of the law. Unless otherwise stated the results shown in this test report refer only to the sample(s) tested.

Attention: To check the authenticity of testing / inspection report & certificate, please contact us at telephone: (86-755) 8307 1443, or email: CN.Doccheck@sgs.com

SGS-CSTC Shanghai Technical Services (Shanghai) Co., Ltd.
Testing Center - Chemical Laboratory

13th Building, No. 889 Yishan Road Xuhui District, Shanghai China 200233

t E&E (86-21) 61402553 f E&E (86-21) 64953679

www.sgsgroup.com.cn

中国·上海·徐汇区宜山路889号3号楼 邮编: 200233

t HL (86-21) 61402594

f HL (86-21) 61156899

e sgs.china@sgs.com

Test Report

No. SHAEC1929071101

Date: 17 Jan 2020

Page 7 of 38

<u>Test Item(s)</u>	<u>CAS NO.</u>	<u>Unit</u>	<u>MDL</u>	<u>001</u>
HCFC-121	354-14-3	µg/g	0.1	ND
HCFC-122	354-21-2	µg/g	0.1	ND
HCFC-123	306-83-2	µg/g	0.1	ND
HCFC-123a	354-23-4	µg/g	0.1	ND
HCFC-124	2837-89-0	µg/g	0.1	ND
HCFC-124a	354-25-6	µg/g	0.1	ND
HCFC-131	359-28-4	µg/g	0.1	ND
HCFC-131a	811-95-0	µg/g	0.1	ND
HCFC-132a	471-43-2	µg/g	0.1	ND
HCFC-132b	1649-08-7	µg/g	0.1	ND
HCFC-133a	75-88-7	µg/g	0.1	ND
HCFC-141b	1717-00-6	µg/g	0.1	ND
HCFC-142b	75-68-3	µg/g	0.1	ND
HCFC-221	422-26-4	µg/g	0.1	ND
HCFC-222	422-30-0	µg/g	0.1	ND
HCFC-223	422-52-6	µg/g	0.1	ND
HCFC-225ca	422-56-0	µg/g	0.1	ND
HCFC-225cb	507-55-1	µg/g	0.1	ND
HCFC-226	431-87-8	µg/g	0.1	ND
HCFC-231	421-94-3	µg/g	0.1	ND
HCFC-232	460-89-9	µg/g	0.1	ND
HCFC-233	7125-84-0	µg/g	0.1	ND
HCFC-234	425-94-5	µg/g	0.1	ND
HCFC-235	460-92-4	µg/g	0.1	ND
HCFC-241	666-27-3	µg/g	0.1	ND
HCFC-242	460-63-9	µg/g	0.1	ND
HCFC-243	338-75-0	µg/g	0.1	ND
HCFC-244	679-85-6	µg/g	0.1	ND
HCFC-251	421-41-0	µg/g	0.1	ND
HCFC-252	819-00-1	µg/g	0.1	ND
HCFC-253	460-35-5	µg/g	0.1	ND
HCFC-261	7799-56-6	µg/g	0.1	ND
HCFC-261	420-97-3	µg/g	0.1	ND
HCFC-262	102738-79-4	µg/g	0.1	ND
HCFC-262	420-99-5	µg/g	0.1	ND
HCFC-271	430-55-7	µg/g	0.1	ND

Short Chained Chlorinated Paraffin (SCCP)



Unless otherwise agreed in writing, this document is issued by the Company subject to its General Conditions of Service printed overleaf, available on request or accessible at <http://www.sgs.com/en/Terms-and-Conditions.aspx> and, for electronic format documents, subject to Terms and Conditions for Electronic Documents at <http://www.sgs.com/en/Terms-and-Conditions/Terms-e-Documents.aspx>. Attention is drawn to the limitation of liability, indemnification and jurisdiction issues defined therein. Any holder of this document is advised that information contained hereon reflects the Company's findings at the time of its intervention only and within the limits of Client's instructions, if any. The Company's sole responsibility is to its Client and this document does not exonerate parties to a transaction from exercising all their rights and obligations under the transaction documents. This document cannot be reproduced except in full, without prior written approval of the Company. Any unauthorized alteration, forgery or falsification of the content or appearance of this document is unlawful and offenders may be prosecuted to the fullest extent of the law. Unless otherwise stated the results shown in this test report refer only to the sample(s) tested.

Attention: To check the authenticity of testing / inspection report & certificate, please contact us at telephone: (86-755) 8307 1443, or email: CN.Doccheck@sgs.com

SGS CSTC (Shanghai) Co., Ltd.
Testing Center - Chemical Laboratory

3rd Building, No. 889 Yishan Road Xuhui District, Shanghai China 200233
中国·上海·徐汇区宜山路889号3号楼 邮编: 200233

t E&E (86-21) 61402553 f E&E (86-21) 64953679 www.sgsgroup.com.cn
t HL (86-21) 61402594 f HL (86-21) 61156899 e sgs.china@sgs.com

Test Report

No. SHAEC1929071101

Date: 17 Jan 2020

Page 8 of 38

Test Method : With reference to US EPA 3550C: 2007, analysis was performed by GC-ECD / GC-NCI-MS.

<u>Test Item(s)</u>	<u>Unit</u>	<u>MDL</u>	<u>001</u>
Short-chain Chlorinated Paraffin (SCCP) (C ₁₀ -C ₁₃)	mg/kg	50	ND

Tris(2-chloroethyl) Phosphate(TCEP), Tris(1-chloro-2-propyl) Phosphate (TCPP), Tris(1,3-dichloro-2-propyl) Phosphate(TDCPP)

Test Method : With reference to US EPA 3550C:2007 and US EPA 8270D: 2014, analysis was performed by GC-MS.

<u>Test Item(s)</u>	<u>CAS NO.</u>	<u>Unit</u>	<u>MDL</u>	<u>001</u>
Tris(2-chloroethyl) Phosphate(TCEP)	115-96-8	mg/kg	5	ND
Tris(1-chloro-2-propyl) Phosphate (TCPP)	13674-84-5	mg/kg	5	ND
Tris(1,3-dichloro-2-propyl) Phosphate(TDCPP)	13674-87-8	mg/kg	5	ND

Hexabromocyclododecane (HBCDD)

Test Method : With reference to US EPA 8270D: 2014, analysis was performed by GC-MS.

<u>Test Item(s)</u>	<u>Unit</u>	<u>MDL</u>	<u>001</u>
Hexabromocyclododecane (HBCDD/HBCD)	mg/kg	10	ND

Asbestos

Test Method : With reference to ISO 22262-1:2012, Analysis was performed by Polarized light microscope (PLM).



Unless otherwise agreed in writing, this document is issued by the Company subject to its General Conditions of Service printed overleaf, available on request or accessible at <http://www.sgs.com/en/Terms-and-Conditions.aspx> and, for electronic format documents, subject to Terms and Conditions for Electronic Documents at <http://www.sgs.com/en/Terms-and-Conditions/Terms-e-Documents.aspx>. Attention is drawn to the limitation of liability, indemnification and jurisdiction issues defined therein. Any holder of this document is advised that information contained hereon reflects the Company's findings at the time of its intervention only and within the limits of Client's instructions, if any. The Company's sole responsibility is to its Client and this document does not exonerate parties to a transaction from exercising all their rights and obligations under the transaction documents. This document cannot be reproduced except in full, without prior written approval of the Company. Any unauthorized alteration, forgery or falsification of the content or appearance of this document is unlawful and offenders may be prosecuted to the fullest extent of the law. Unless otherwise stated the results shown in this test report refer only to the sample(s) tested.

Attention: To check the authenticity of testing / inspection report & certificate, please contact us at telephone: (86-755) 8307 1443, or email: CN.Doccheck@sgs.com

SGS-CSTC (Shanghai) Technical Services Co., Ltd.
Testing Center-Chemical Laboratory

3rd Building, No. 889 Yishan Road Xuhui District, Shanghai China 200233
中国·上海·徐汇区宜山路889号3号楼 邮编: 200233

t E&E (86-21) 61402553 f E&E (86-21) 64953679 www.sgsgroup.com.cn
t HL (86-21) 61402594 f HL (86-21) 61156899 e sgs.china@sgs.com

Test Report

No. SHAEC1929071101

Date: 17 Jan 2020

Page 9 of 38

<u>Test Item(s)</u>	<u>CAS NO.</u>	<u>Unit</u>	<u>MDL</u>	<u>001</u>
Actinolite	77536-66-4	%	0.1	Negative
Amosite	12172-73-5	%	0.1	Negative
Anthophyllite	77536-67-5	%	0.1	Negative
Chrysotile	12001-29-5/ 132207-32-0	%	0.1	Negative
Crocidolite	12001-28-4	%	0.1	Negative
Tremolite	77536-68-6	%	0.1	Negative

Notes :

(1) Negative = the absence of asbestos, Positive = the presence of asbestos.

Formaldehyde

Test Method : With reference to ISO 17226-1:2018, analysis was performed by HPLC-DAD.

<u>Test Item(s)</u>	<u>Unit</u>	<u>MDL</u>	<u>001</u>
Formaldehyde	mg/kg	16	ND

PVC (Polyvinyl chloride)

Test Method : SGS in-house method (SHTC-CHEM-SOP-115-T), analysis was performed by FTIR/HATR.

<u>Test Item(s)</u>	<u>CAS NO.</u>	<u>Unit</u>	<u>MDL</u>	<u>001</u>
PVC	9002-86-2	-	-	Negative

Notes :

(1) Negative=Undetectable,Positive=Detectable

Dimethyl fumarate(DMF)

Test Method : Solvent extraction, analysis was performed by GC-MS.

<u>Test Item(s)</u>	<u>Unit</u>	<u>MDL</u>	<u>001</u>
Dimethyl fumarate(DMF)	mg/kg	0.1	ND



Unless otherwise agreed in writing, this document is issued by the Company subject to its General Conditions of Service printed overleaf, available on request or accessible at <http://www.sgs.com/en/Terms-and-Conditions.aspx> and, for electronic format documents, subject to Terms and Conditions for Electronic Documents at <http://www.sgs.com/en/Terms-and-Conditions/Terms-e-Documents.aspx>. Attention is drawn to the limitation of liability, indemnification and jurisdiction issues defined therein. Any holder of this document is advised that information contained hereon reflects the Company's findings at the time of its intervention only and within the limits of Client's instructions, if any. The Company's sole responsibility is to its Client and this document does not exonerate parties to a transaction from exercising all their rights and obligations under the transaction documents. This document cannot be reproduced except in full, without prior written approval of the Company. Any unauthorized alteration, forgery or falsification of the content or appearance of this document is unlawful and offenders may be prosecuted to the fullest extent of the law. Unless otherwise stated the results shown in this test report refer only to the sample(s) tested.

Attention: To check the authenticity of testing / inspection report & certificate, please contact us at telephone: (86-755) 8307 1443, or email: CN.Doccheck@sgs.com

SGS-CTC (Shanghai) Technical Services (Shanghai) Co., Ltd.
Testing Center - Chemical Laboratory

13th Building, No. 889 Yishan Road Xuhui District, Shanghai China 200233
中国·上海·徐汇区宜山路889号3号楼 邮编: 200233

t E&E (86-21) 61402553 f E&E (86-21) 64953679
t HL (86-21) 61402594 f HL (86-21) 61156899

www.sgs.com
sgs.china@sgs.com

DMF(N, N-dimethylformamide)

Test Method : With reference to US EPA 8270D: 2014, analysis was performed by GC-MS

<u>Test Item(s)</u>	<u>CAS NO.</u>	<u>Unit</u>	<u>MDL</u>	<u>001</u>
DMF(N, N-dimethylformamide)	68-12-2	mg/kg	5.0	ND

Bisphenol-A

Test Method : Extraction by organic solvent, analysis by HPLC-DAD-MS.

<u>Test Item(s)</u>	<u>Unit</u>	<u>MDL</u>	<u>001</u>
Bisphenol-A	mg/kg	1	ND

Polychlorinated Terphenyls (PCTs)

Test Method : With reference to US EPA 8082A: 2007, analysis was performed by GC-MS

<u>Test Item(s)</u>	<u>Unit</u>	<u>MDL</u>	<u>001</u>
Aroclor 5432	mg/kg	5	ND
Aroclor 5442	mg/kg	5	ND
Aroclor 5460	mg/kg	5	ND

Polychlorinated Biphenyls (PCBs)

Test Method : With reference to US EPA 8082A: 2007, analysis was performed by GC-MS

<u>Test Item(s)</u>	<u>CAS NO.</u>	<u>Unit</u>	<u>MDL</u>	<u>001</u>
2,4,4'-Trichlorobiphenyl (PCB 28)	7012-37-5	mg/kg	0.5	ND
2,2',5,5'-Tetrachloro-biphenyl (PCB 52)	35693-99-3	mg/kg	0.5	ND
2,2',4,5,5'-Pentachloro-biphenyl (PCB 101)	37680-73-2	mg/kg	0.5	ND
2,3',4,4',5-Pentachlorobiphenyl (PCB 118)	31508-00-6	mg/kg	0.5	ND
2,2',3,4,4',5'-Hexachloro-biphenyl (PCB 138)	35065-28-2	mg/kg	0.5	ND
2,2',4,4',5,5'-Hexachloro-biphenyl (PCB 153)	35065-27-1	mg/kg	0.5	ND
2,2',3,4,4',5,5'-Heptachlorobiphenyl (PCB 180)	35065-29-3	mg/kg	0.5	ND

Organic-tin compounds



Unless otherwise agreed in writing, this document is issued by the Company subject to its General Conditions of Service printed overleaf, available on request or accessible at <http://www.sgs.com/en/Terms-and-Conditions.aspx> and, for electronic format documents, subject to Terms and Conditions for Electronic Documents at <http://www.sgs.com/en/Terms-and-Conditions/Terms-e-Document.aspx>. Attention is drawn to the limitation of liability, indemnification and jurisdiction issues defined therein. Any holder of this document is advised that information contained hereon reflects the Company's findings at the time of its intervention only and within the limits of Client's instructions, if any. The Company's sole responsibility is to its Client and this document does not exonerate parties to a transaction from exercising all their rights and obligations under the transaction documents. This document cannot be reproduced except in full, without prior written approval of the Company. Any unauthorized alteration, forgery or falsification of the content or appearance of this document is unlawful and offenders may be prosecuted to the fullest extent of the law. Unless otherwise stated the results shown in this test report refer only to the sample(s) tested.

Attention: To check the authenticity of testing / inspection report & certificate, please contact us at telephone: (86-755) 8307 1443, or email: CN.Doccheck@sgs.com

SGS-CTC (Shanghai) Technical Services Co., Ltd.
Testing Center-Chemical Laboratory

13th Building, No. 889 Yishan Road Xuhui District, Shanghai China 200233 t E&E (86-21) 61402553 f E&E (86-21) 64953679 www.sgsgroup.com.cn
中国·上海·徐汇区宜山路889号3号楼 邮编: 200233 t HL (86-21) 61402594 f HL (86-21) 61156899 e sgs.china@sgs.com

Test Report

No. SHAEC1929071101

Date: 17 Jan 2020

Page 11 of 38

Test Method : With reference to ISO 17353: 2004 with carbamate, analysis was performed by GC-MS.

Test Item(s)	Unit	MDL	001
Dibutyl tin (DBT)	mg/kg	0.5	ND
Tributyl tin (TBT)	mg/kg	0.5	ND
Diocetyl tin (DOT)	mg/kg	0.5	ND
Triphenyl tin (TPHT)	mg/kg	0.5	ND
Bis(tributyltin) oxide (TBTO) ♦	mg/kg	0.5	ND
2-ethylhexyl 10-ethyl-4,4-dioctyl-7-oxo-8-oxa-3,5-dithia-4-stannatetradecanoate (DOTE) ♦	mg/kg	0.5	ND
Reaction mass of 2-ethylhexyl10-ethyl-4,4-dioctyl-7-oxo-8-oxa-3,5-dithia-4-stannatetradecanoate and 2-ethylhexyl10-ethyl-4-[[2-[(2-ethylhexyl)oxy]-2-oxoethyl]thio]-4-octyl-7-oxo-8-oxa-3,5-dithia-4-stannaetradecanoate(Reaction mass of DOTEand MOTE)♦	mg/kg	0.5	ND

Notes :

(1) ♦ = TBTO, DOTE & Reaction Mass of DOTE and MOTE are back calculated based on the worst-case scenario of TBT, DOT and MOT.

Benzotriazole UV Absorbant

Test Method : With reference to US EPA 3550C: 2007, analysis was performed by GC-MS.

Test Item(s)	Unit	MDL	001
2-(3,5-Di-tert-butyl-2-hydroxyphenyl) benzotriazole (UV-320) (CAS No: 3846-71-7)	mg/kg	5	ND
2-(2'-hydroxy-3',5'-di-tert- amylphenyl) benzotriazole (UV-328) (CAS No: 25973-55-1)	mg/kg	5	ND
2-(3',5'-Di-tert-butyl-2'-hydroxyphenyl)-5-chloro benzotriazole (UV-327) (CAS No: 3864-99-1)	mg/kg	5	ND
TinUVin 350 (UV-350) (CAS No: 36437-37-3)	mg/kg	5	ND

PFOS (Perfluorooctane Sulfonates) and PFOA (Perfluorooctanoic Acid)

Test Method : With reference to US EPA 3550C: 2007, analysis was performed by HPLC-MS.

Test Item(s)	Unit	MDL	001
Perfluorooctanesulfonate (PFOS)^	mg/kg	10	ND
Perfluorooctanoic Acid (PFOA)	mg/kg	10	ND



Unless otherwise agreed in writing, this document is issued by the Company subject to its General Conditions of Service printed overleaf, available on request or accessible at <http://www.sgs.com/en/Terms-and-Conditions.aspx> and, for electronic format documents, subject to Terms and Conditions for Electronic Documents at <http://www.sgs.com/en/Terms-and-Conditions/Terms-e-Document.aspx>. Attention is drawn to the limitation of liability, indemnification and jurisdiction issues defined therein. Any holder of this document is advised that information contained hereon reflects the Company's findings at the time of its intervention only and within the limits of Client's instructions, if any. The Company's sole responsibility is to its Client and this document does not exonerate parties to a transaction from exercising all their rights and obligations under the transaction documents. This document cannot be reproduced except in full, without prior written approval of the Company. Any unauthorized alteration, forgery or falsification of the content or appearance of this document is unlawful and offenders may be prosecuted to the fullest extent of the law. Unless otherwise stated the results shown in this test report refer only to the sample(s) tested.

Attention: To check the authenticity of testing /inspection report & certificate, please contact us at telephone: (86-755) 8307 1443, or email: CN.Doccheck@sgs.com

SGS-CSTC Shanghai Technical Services (Shanghai) Co., Ltd.
Testing Center-Chemical Laboratory

13th Building, No.889 Yishan Road Xuhui District, Shanghai China 200233
中国·上海·徐汇区宜山路889号3号楼 邮编: 200233

t E&E (86-21) 61402553 f E&E (86-21) 64953679 www.sgs.com.cn
t HL (86-21) 61402594 f HL (86-21) 61156899 e sgs.china@sgs.com

Test Report

No. SHAEC1929071101

Date: 17 Jan 2020

Page 12 of 38

Notes :

(1) ^ PFOS refer to Perfluorooctanesulfonic acid and its derivatives including esulfonic acid, Perfluorooctane sulfonamide, N-Methylperfluorooctane sulfonamide, N-Ethylperfluorooctane sulfonamide, N-Methylperfluorooctane sulfonamidoethanol and N-Ethylperfluorooctane sulfonamidoethanol.

Inorganic SVHC

Test Method : SGS In-House method-SHTC-CHEM-SOP-97-T, analyzed by ICP-OES.

Test Item(s)	CAS NO.	Unit	MDL	001
Diarsenic pentaoxide	1303-28-2	%	0.005	ND
Diarsenic trioxide	1327-53-3	%	0.005	ND
Boric acid	10043-35-3	%	0.005	ND
Disodium tetraborate, anhydrous	11113-50-1	%	0.005	ND
	1303-96-4			
	1330-43-4			
Tetraboron disodium heptaoxide, hydrate	12179-04-3	%	0.005	ND
	12267-73-1			
Diboron trioxide	1303-86-2	%	0.005	ND

Notes :

(1) Calculated concentration of boric compounds are based on the total boron for liquid, powder and paste samples and water extractive boron for other samples by ICP-OES.

Organic SVHC

Test Method : SGS In-House method- SHTC-CHEM-SOP-302-T, Analyzed by GC-MS, HPLC-DAD/MS

Test Item(s)	CAS NO.	Unit	MDL	001
4-(1,1,3,3 tetramethylbutyl)phenol	140-66-9	%	0.05	ND
Bis(2 methoxyethyl) ether	111-96-6	%	0.05	ND
N,N dimethylacetamide	127-19-5	%	0.05	ND
1,2-dimethoxyethane; ethylene glycol dimethyl ether (EGDME)	110-71-4	%	0.05	ND
Trixylyl phosphate	25155-23-1	%	0.05	ND
2-(2H-benzotriazol-2-yl)-4,6-ditertpentylphenol (UV-328)	25973-55-1	%	0.05	ND
2-benzotriazol-2-yl-4,6-di-tert-butylphenol (UV-320)	3846-71-7	%	0.05	ND
1,2-Diethoxyethane	629-14-1	%	0.05	ND
1,2-bis(2-methoxyethoxy)ethane (TEGDME; triglyme)	112-49-2	%	0.05	ND



Unless otherwise agreed in writing, this document is issued by the Company subject to its General Conditions of Service printed overleaf, available on request or accessible at <http://www.sgs.com/en/Terms-and-Conditions.aspx> and, for electronic format documents, subject to Terms and Conditions for Electronic Documents at <http://www.sgs.com/en/Terms-and-Conditions/Terms-e-Document.aspx>. Attention is drawn to the limitation of liability, indemnification and jurisdiction issues defined therein. Any holder of this document is advised that information contained hereon reflects the Company's findings at the time of its intervention only and within the limits of Client's instructions, if any. The Company's sole responsibility is to its Client and this document does not exonerate parties to a transaction from exercising all their rights and obligations under the transaction documents. This document cannot be reproduced except in full, without prior written approval of the Company. Any unauthorized alteration, forgery or falsification of the content or appearance of this document is unlawful and offenders may be prosecuted to the fullest extent of the law. Unless otherwise stated the results shown in this test report refer only to the sample(s) tested.

Attention: To check the authenticity of testing /inspection report & certificate, please contact us at telephone: (86-755) 8307 1443, or email: CN.Doccheck@sgs.com

SGS-CSTC Shanghai Technical Services (Shanghai) Co., Ltd.
Testing Center-Chemical Laboratory

3rd Building, No. 889 Yishan Road Xuhui District, Shanghai China 200233 t E&E (86-21) 61402553 f E&E (86-21) 64953679 www.sgs.com.cn
中国·上海·徐汇区宜山路889号3号楼 邮编: 200233 t HL (86-21) 61402594 f HL (86-21) 61156899 e sgs.china@sgs.com

Test Report

No. SHAEC1929071101

Date: 17 Jan 2020

Page 13 of 38

Test Item(s)	CAS NO.	Unit	MDL	001
Hexahydromethylphthalic anhydride, Hexahydro-4-methylphthalic anhydride, Hexahydro-1-methylphthalic anhydride, Hexahydro-3-methylphthalic anhydride	☆	%	0.05	ND
Disodium 3,3'- [[1,1'-biphenyl]-4,4'-diylbis(azo)]bis(4-aminonaphthalene-1- sulphonate) (C.I. Direct Red 28)	573-58-0	%	0.05	ND
Imidazolidine-2-thione; (2-imidazoline-2-thiol)	96-45-7	%	0.05	ND
Disodium 4-amino-3-[[4'-[(2,4-diaminophenyl)azo] [1,1'-biphenyl]-4-yl]azo] -5-hydroxy-6- (phenylazo)naphthalene-2,7-disulphonate (C.I. Direct Black 38)	1937-37-7	%	0.05	ND
Perfluorononan-1-oic-acid and its sodium and ammonium salts	375-95-1, 21049-39-8, 4149-60-4	%	0.05	ND
Nonadecafluorodecanoic acid (PFDA) and its sodium and ammonium salts	3108-42-7, 335-76-2, 3830-45-3	%	0.05	ND
1,3-propanesultone	1120-71-4	%	0.05	ND
Perfluorohexane-1-sulphonic acid and its salts		%	0.05	ND
Dodecachloropentacyclo[12.2.1.16.9.02,13.05,10]octadeca -7,15-diene ("Dechlorane Plus"™) [covering any of its individual anti- and syn-isomers or any combination thereof]		%	0.05	ND
Benz[a]anthracene	56-55-3, 1718-53-2	%	0.05	ND
Chrysene	218-01-9, 1719-03-5	%	0.05	ND

Notes :

- (1) ☆ CAS No. of Hexahydromethylphthalic anhydride, Hexahydro-4-methylphthalic anhydride, Hexahydro-1-methylphthalic anhydride, Hexahydro-3-methylphthalic anhydride: 25550-51-0, 19438-60-9, 48122-14-1, 57110-29-9; EC No. of those: 247-094-1, 243-072-0, 256-356-4, 260-566-1.

Phthalates Content

Test Method : With reference to IEC 62321-8:2017, determination of phthalates by GC-MS.

Test Item(s)	CAS NO.	Unit	MDL	001
Di-butyl Phthalate (DBP)	84-74-2	mg/kg	50	ND
Di-2-Ethyl Hexyl Phthalate (DEHP)	117-81-7	mg/kg	50	ND
Benzyl Butyl Phthalate (BBP)	85-68-7	mg/kg	50	ND



Unless otherwise agreed in writing, this document is issued by the Company subject to its General Conditions of Service printed overleaf, available on request or accessible at <http://www.sgs.com/en/Terms-and-Conditions.aspx> and, for electronic format documents, subject to Terms and Conditions for Electronic Documents at <http://www.sgs.com/en/Terms-and-Conditions/Terms-e-Documents.aspx>. Attention is drawn to the limitation of liability, indemnification and jurisdiction issues defined therein. Any holder of this document is advised that information contained hereon reflects the Company's findings at the time of its intervention only and within the limits of Client's instructions, if any. The Company's sole responsibility is to its Client and this document does not exonerate parties to a transaction from exercising all their rights and obligations under the transaction documents. This document cannot be reproduced except in full, without prior written approval of the Company. Any unauthorized alteration, forgery or falsification of the content or appearance of this document is unlawful and offenders may be prosecuted to the fullest extent of the law. Unless otherwise stated the results shown in this test report refer only to the sample(s) tested.

Attention: To check the authenticity of testing / inspection report & certificate, please contact us at telephone: (86-755) 8307 1443, or email: CN.Doccheck@sgs.com

SGS-CSTC Shanghai Technical Services (Shanghai) Co., Ltd.
Testing Center - Chemical Laboratory

13th Building, No. 889 Yishan Road Xuhui District, Shanghai China 200233
中国·上海·徐汇区宜山路889号3号楼 邮编: 200233

t E&E (86-21) 61402553 f E&E (86-21) 64953679 www.sgs.com.cn
t HL (86-21) 61402594 f HL (86-21) 61156899 e sgs.china@sgs.com

Test Report

No. SHAEC1929071101

Date: 17 Jan 2020

Page 14 of 38

Test Item(s)	CAS NO.	Unit	MDL	001
Diisononyl Phthalate (DINP)	28553-12-0 /68515-48-0	mg/kg	50	ND
Di-n-octyl Phthalate (DNOP)	117-84-0	mg/kg	50	ND
Diisodecyl Phthalate (DIDP)	26761-40-0 /68515-49-1	mg/kg	50	ND
Diisobutyl Phthalates (DIBP)	84-69-5	mg/kg	50	ND
Dihexyl Phthalates (DHP, DHxP)	84-75-3	mg/kg	50	ND
Bis(2-methoxyethyl) Phthalate (DMEP)	117-82-8	mg/kg	50	ND
Diisopentylphthalate (DiPP)	605-50-5	mg/kg	50	ND
iso-pentyl n-Pentyl phthalate (iPnPP)	776297-69-9	mg/kg	50	ND
Diisoheptyl phthalate (DIHP)	71888-89-6	mg/kg	50	ND
1,2-benzenedicarboxylic acid, di-C6-10-alkyl esters; 1,2-benzenedicarboxylic acid, mixed decyl and hexyl and octyl diesters with ≥ 0.3% of dihexyl phthalate	68515-51-5/ 68648-93-1	mg/kg	50	ND
1,2-Benzenedicarboxylic acid, dipentyl ester, branched and linear	84777-06-0	mg/kg	50	ND
Di-n-pentyl Phthalates (DnPP)	131-18-0	mg/kg	50	ND
1,2-Benzenedicarboxylic acid, di-C7-11-branched and linear alkyl esters(DHNUP)	68515-42-4	mg/kg	50	ND

Polycyclic aromatic hydrocarbons (PAHs)

Test Method : With reference to AfPS GS 2014:01 PAK, analysis was performed by GC-MS.

Test Item(s)	Unit	MDL	001
Benzo(a)pyrene(BaP)	mg/kg	0.1	ND
Benzo(e)pyrene(BeP)	mg/kg	0.1	ND
Benzo(a)anthracene(BaA)	mg/kg	0.1	ND
Benzo(b)fluoranthene(BbF)	mg/kg	0.1	ND
Benzo(j)fluoranthene(BjF)	mg/kg	0.1	ND
Benzo(k)fluoranthene(BkF)	mg/kg	0.1	ND
Chrysene(CHR)	mg/kg	0.1	ND
Dibenzo(a,h)anthracene(DBA)	mg/kg	0.1	ND
Benzo(g,h,i)perylene(BPE)	mg/kg	0.1	ND
Indeno(1,2,3-c,d)pyrene(IPY)	mg/kg	0.1	ND
Acenaphthylene(ANY)	mg/kg	0.1	ND
Acenaphthene(ANA)	mg/kg	0.1	ND
Fluorene(FLU)	mg/kg	0.1	ND
Phenanthrene(PHE)	mg/kg	0.1	ND
Pyrene(PYR)	mg/kg	0.1	ND



Unless otherwise agreed in writing, this document is issued by the Company subject to its General Conditions of Service printed overleaf, available on request or accessible at <http://www.sgs.com/en/Terms-and-Conditions.aspx> and, for electronic format documents, subject to Terms and Conditions for Electronic Documents at <http://www.sgs.com/en/Terms-and-Conditions/Terms-e-Document.aspx>. Attention is drawn to the limitation of liability, indemnification and jurisdiction issues defined therein. Any holder of this document is advised that information contained hereon reflects the Company's findings at the time of its intervention only and within the limits of Client's instructions, if any. The Company's sole responsibility is to its Client and this document does not exonerate parties to a transaction from exercising all their rights and obligations under the transaction documents. This document cannot be reproduced except in full, without prior written approval of the Company. Any unauthorized alteration, forgery or falsification of the content or appearance of this document is unlawful and offenders may be prosecuted to the fullest extent of the law. Unless otherwise stated the results shown in this test report refer only to the sample(s) tested.

Attention: To check the authenticity of testing /inspection report & certificate, please contact us at telephone: (86-755) 8307 1443, or email: CN.Doccheck@sgs.com

SGS-CSTC Shanghai Technical Service Co., Ltd.
Testing Center - Chemical Laboratory

13th Building, No. 889 Yishan Road Xuhui District, Shanghai China 200233
中国·上海·徐汇区宜山路889号3号楼 邮编: 200233

t E&E (86-21) 61402553 f E&E (86-21) 64953679 www.sgsgroup.com.cn
t HL (86-21) 61402594 f HL (86-21) 61156899 e sgs.china@sgs.com

Test Item(s)	Unit	MDL	001
Anthracene(ANT)	mg/kg	0.1	ND
Fluoranthene(FLT)	mg/kg	0.1	ND
Sum of Acenaphthylene, Acenaphthene, Fluorene, Phenanthrene, Pyrene, Anthracene, Fluoranthene	mg/kg	-	ND
Naphthalene(NAP)	mg/kg	0.1	ND
Sum of 18 PAHs	mg/kg	-	ND

AfPS (German commission for Product Safety) : GS PAHs requirements

Parameter	Category 1 Material intended to be put in the mouth or toys with intended skin contact (longer than 30 s).	Category 2		Category 3	
		Toy under 2009/48/EC	Other products under ProdSG	Toy under 2009/48/EC	Other products under ProdSG
Benzo(a)pyrene mg/kg	< 0.2	< 0.2	< 0.5	< 0.5	< 1
Benzo(e)pyrene mg/kg	< 0.2	< 0.2	< 0.5	< 0.5	< 1
Benzo(a)anthracene mg/kg	< 0.2	< 0.2	< 0.5	< 0.5	< 1
Benzo(b)fluoranthene mg/kg	< 0.2	< 0.2	< 0.5	< 0.5	< 1
Benzo(j)fluoranthene mg/kg	< 0.2	< 0.2	< 0.5	< 0.5	< 1
Benzo(k)fluoranthene mg/kg	< 0.2	< 0.2	< 0.5	< 0.5	< 1
Chrysene mg/kg	< 0.2	< 0.2	< 0.5	< 0.5	< 1
Dibenzo(a,h)anthracene mg/kg	< 0.2	< 0.2	< 0.5	< 0.5	< 1
Benzo(g,h,i)perylene mg/kg	< 0.2	< 0.2	< 0.5	< 0.5	< 1
Indeno(1,2,3-cd)pyrene mg/kg	< 0.2	< 0.2	< 0.5	< 0.5	< 1
Acenaphthylene, Acenaphthene, fluorene, phenanthrene, pyrene, anthracene, fluoranthene, mg/kg	< 1 Sum	< 5 Sum	< 10 Sum	< 20 Sum	< 50 Sum
Naphthalene, mg/kg	< 1	< 2		< 10	
Sum of 18 PAHs	< 1	< 5	< 10	< 20	< 50

Azo Dyes

Test Method : According to Ref. EN 14362-1:2012- Analysis was conducted with GC-MS/HPLC-DAD.



Unless otherwise agreed in writing, this document is issued by the Company subject to its General Conditions of Service printed overleaf, available on request or accessible at <http://www.sgs.com/en/Terms-and-Conditions.aspx> and, for electronic format documents, subject to Terms and Conditions for Electronic Documents at <http://www.sgs.com/en/Terms-and-Conditions/Terms-e-Documents.aspx>. Attention is drawn to the limitation of liability, indemnification and jurisdiction issues defined therein. Any holder of this document is advised that information contained hereon reflects the Company's findings at the time of its intervention only and within the limits of Client's instructions, if any. The Company's sole responsibility is to its Client and this document does not exonerate parties to a transaction from exercising all their rights and obligations under the transaction documents. This document cannot be reproduced except in full, without prior written approval of the Company. Any unauthorized alteration, forgery or falsification of the content or appearance of this document is unlawful and offenders may be prosecuted to the fullest extent of the law. Unless otherwise stated the results shown in this test report refer only to the sample(s) tested.

Attention: To check the authenticity of testing /inspection report & certificate, please contact us at telephone: (86-755) 8307 1443, or email: CN.Doccheck@sgs.com
 13th Building, No.889 Yishan Road Xuhui District, Shanghai China 200233 t E&E (86-21) 61402553 f E&E (86-21) 64953679 www.sgs.com.cn
 中国·上海·徐汇区宜山路889号3号楼 邮编: 200233 t HL (86-21) 61402594 f HL (86-21) 61156899 e sgs.china@sgs.com

Test Item(s)	CAS NO.	Unit	MDL	001
4-Aminobiphenyl	92-67-1	mg/kg	5	ND
Benzidine	92-87-5	mg/kg	5	ND
4-chloro-o-toluidine	95-69-2	mg/kg	5	ND
2-naphthylamine	91-59-8	mg/kg	5	ND
o-aminoazotoluene	97-56-3	mg/kg	5	ND
5-nitro-o-toluidine / 2-Amino-4-nitrotoluene	99-55-8	mg/kg	5	ND
4-chloroaniline	106-47-8	mg/kg	5	ND
4-methoxy-m-phenylenediamine / 2,4-Diaminoanisole	615-05-4	mg/kg	5	ND
4,4'-diaminodiphenylmethane	101-77-9	mg/kg	5	ND
3,3'-dichlorobenzidine	91-94-1	mg/kg	5	ND
3,3'-dimethoxybenzidine	119-90-4	mg/kg	5	ND
3,3'-dimethylbenzidine	119-93-7	mg/kg	5	ND
3,3'-Dimethyl-4,4'-diaminodiphenylmethane / 4,4'-methylenedi-o-toluidine	838-88-0	mg/kg	5	ND
p-cresidine	120-71-8	mg/kg	5	ND
4,4'-methylene-bis-(2-chloroaniline)	101-14-4	mg/kg	5	ND
4,4'-oxydianiline	101-80-4	mg/kg	5	ND
4,4'-thiodianiline	139-65-1	mg/kg	5	ND
o-toluidine	95-53-4	mg/kg	5	ND
4-methyl-m-phenylenediamine / 2,4-Toluylendiamine	95-80-7	mg/kg	5	ND
2,4,5-trimethylaniline	137-17-7	mg/kg	5	ND
4-aminoazobenzene	60-09-3	mg/kg	5	ND
O-Anisidine	90-04-0	mg/kg	5	ND
2,4-Xylidine	95-68-1	mg/kg	5	ND
2,6-Xylidine	87-62-7	mg/kg	5	ND
Conclusion				##

Notes :

- (1) The EN 14362-1:2012 method will enable further cleavage of 4-aminoazobenzene to non-forbidden amines: aniline and 1,4-phenylenediamine. If aniline and/or 1,4-phenylenediamine is not found (i.e. 5mg/kg) by mentioned test method, test result for 4-aminoazobenzene (CAS no. 60-09-3) is considered as "not detected" (i.e. <5mg/kg). Otherwise, the test method of EN 14362-3:2012 will be employed to verify the presence of 4-aminoazobenzene.
- (2) ## = For textiles no relevant amine exceeding 30 ppm (mg/kg) is required, the test method is only applicable for textile and the result is only for client's information.
- (3) Whenever 4-aminodiphenyl (CAS number 92-67-1), 2-naphthylamine (CAS number 91-59-8) and 4-methoxy-m-phenylene-diamine (CAS number 615-05-4) is found, the use of banned azo colorants cannot be reliably ascertained without additional information, e.g. the chemical structure of the colorants used.
- (4) In case polyurethane materials are used, e.g. PU foams and coatings and in prints, it cannot be ruled



Unless otherwise agreed in writing, this document is issued by the Company subject to its General Conditions of Service printed overleaf, available on request or accessible at <http://www.sgs.com/en/Terms-and-Conditions.aspx> and, for electronic format documents, subject to Terms and Conditions for Electronic Documents at <http://www.sgs.com/en/Terms-and-Conditions/Terms-e-Document.aspx>. Attention is drawn to the limitation of liability, indemnification and jurisdiction issues defined therein. Any holder of this document is advised that information contained hereon reflects the Company's findings at the time of its intervention only and within the limits of Client's instructions, if any. The Company's sole responsibility is to its Client and this document does not exonerate parties to a transaction from exercising all their rights and obligations under the transaction documents. This document cannot be reproduced except in full, without prior written approval of the Company. Any unauthorized alteration, forgery or falsification of the content or appearance of this document is unlawful and offenders may be prosecuted to the fullest extent of the law. Unless otherwise stated the results shown in this test report refer only to the sample(s) tested.

Attention: To check the authenticity of testing / inspection report & certificate, please contact us at telephone: (86-755) 8307 1443, or email: CN.Doccheck@sgs.com

13th Building, No. 889 Yishan Road Xuhui District, Shanghai China 200233 t E&E (86-21) 61402553 f E&E (86-21) 64953679 www.sgsgroup.com.cn
 中国·上海·徐汇区宜山路889号3号楼 邮编: 200233 t HL (86-21) 61402594 f HL (86-21) 61156899 e sgs.china@sgs.com

out that certain amines, e.g. 4,4'-methylene-dianiline (MDA, CAS number 101-77-9) and 2,4-toluylen-diamine (TDA, CAS number 95-80-7) are released from the PU component and not from a banned azo colorant.

(5) In case of pigment prints care has to be taken that 4,4'-methylene-dianiline (MDA, CAS number 101-77-9) is not released from a source of banned azo colorants but from e.g. a chemical fixing agent.

(6) These tests were subcontracted to SGS Ningbo Chemical Lab.

Benzenamine,N-phenyl-,Reaction Products with Styrene and 2,4,4-Trimethylpentene (BNST)

Test Method : With reference to EPA method 3550C:2007 & EPA method 8270D: 2014, analysis was performed by GC-MS.

<u>Test Item(s)</u>	<u>CAS NO.</u>	<u>Unit</u>	<u>MDL</u>	<u>001</u>
Benzenamine,N-phenyl-,Reaction Products with Styrene and 2,4,4-Trimethylpentene (BNST)	68921-45-9	mg/kg	10	ND



Unless otherwise agreed in writing, this document is issued by the Company subject to its General Conditions of Service printed overleaf, available on request or accessible at <http://www.sgs.com/en/Terms-and-Conditions.aspx> and, for electronic format documents, subject to Terms and Conditions for Electronic Documents at <http://www.sgs.com/en/Terms-and-Conditions/Terms-e-Document.aspx>. Attention is drawn to the limitation of liability, indemnification and jurisdiction issues defined therein. Any holder of this document is advised that information contained hereon reflects the Company's findings at the time of its intervention only and within the limits of Client's instructions, if any. The Company's sole responsibility is to its Client and this document does not exonerate parties to a transaction from exercising all their rights and obligations under the transaction documents. This document cannot be reproduced except in full, without prior written approval of the Company. Any unauthorized alteration, forgery or falsification of the content or appearance of this document is unlawful and offenders may be prosecuted to the fullest extent of the law. Unless otherwise stated the results shown in this test report refer only to the sample(s) tested.

Attention: To check the authenticity of testing /inspection report & certificate, please contact us at telephone: (86-755) 8307 1443, or email: CN.Doccheck@sgs.com

ATTACHMENTS

Elements (IEC62321) Testing Flow Chart

1) These samples were dissolved totally by pre-conditioning method according to below flow chart.

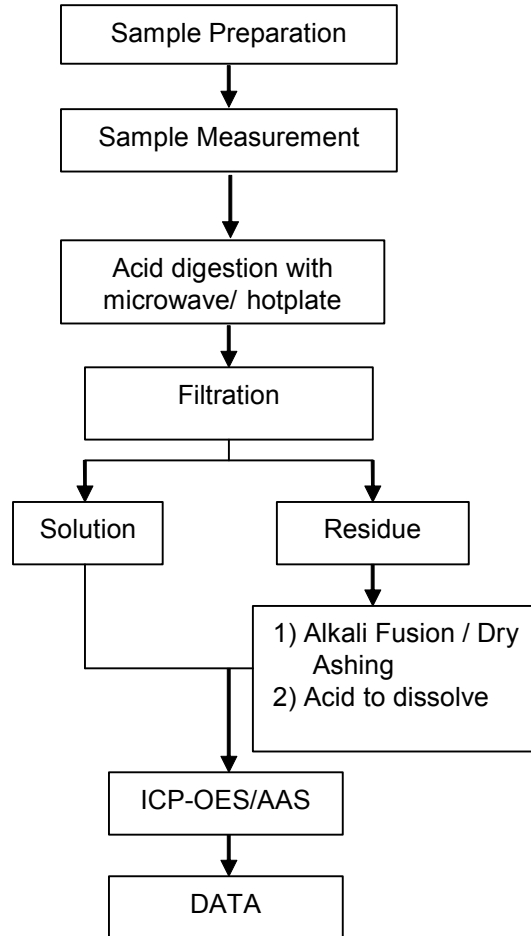

Unless otherwise agreed in writing, this document is issued by the Company subject to its General Conditions of Service printed overleaf, available on request or accessible at <http://www.sgs.com/en/Terms-and-Conditions.aspx> and, for electronic format documents, subject to Terms and Conditions for Electronic Documents at <http://www.sgs.com/en/Terms-and-Conditions/Terms-e-Document.aspx>. Attention is drawn to the limitation of liability, indemnification and jurisdiction issues defined therein. Any holder of this document is advised that information contained hereon reflects the Company's findings at the time of its intervention only and within the limits of Client's instructions, if any. The Company's sole responsibility is to its Client and this document does not exonerate parties to a transaction from exercising all their rights and obligations under the transaction documents. This document cannot be reproduced except in full, without prior written approval of the Company. Any unauthorized alteration, forgery or falsification of the content or appearance of this document is unlawful and offenders may be prosecuted to the fullest extent of the law. Unless otherwise stated the results shown in this test report refer only to the sample(s) tested.

Attention: To check the authenticity of testing / inspection report & certificate, please contact us at telephone: (86-755) 8307 1443, or email: CN.Doccheck@sgs.com

ATTACHMENTS

Hexavalent Chromium (Cr(VI)) Testing Flow Chart

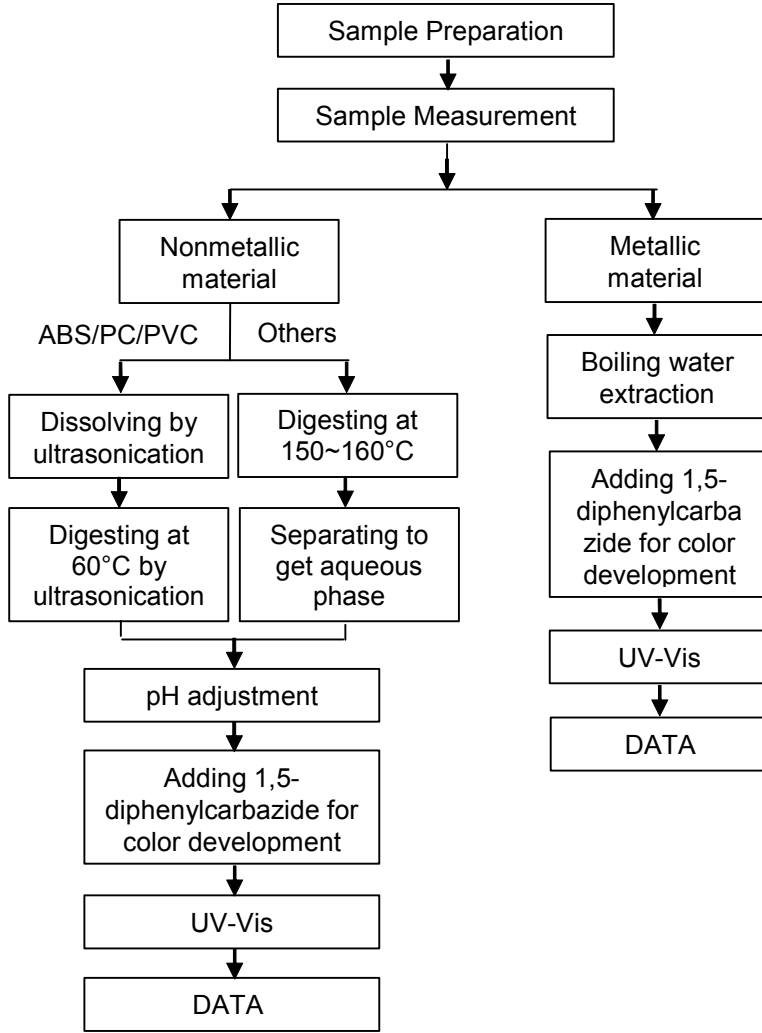

Unless otherwise agreed in writing, this document is issued by the Company subject to its General Conditions of Service printed overleaf, available on request or accessible at <http://www.sgs.com/en/Terms-and-Conditions.aspx> and, for electronic format documents, subject to Terms and Conditions for Electronic Documents at <http://www.sgs.com/en/Terms-and-Conditions/Terms-e-Document.aspx>. Attention is drawn to the limitation of liability, indemnification and jurisdiction issues defined therein. Any holder of this document is advised that information contained hereon reflects the Company's findings at the time of its intervention only and within the limits of Client's instructions, if any. The Company's sole responsibility is to its Client and this document does not exonerate parties to a transaction from exercising all their rights and obligations under the transaction documents. This document cannot be reproduced except in full, without prior written approval of the Company. Any unauthorized alteration, forgery or falsification of the content or appearance of this document is unlawful and offenders may be prosecuted to the fullest extent of the law. Unless otherwise stated the results shown in this test report refer only to the sample(s) tested.

Attention: To check the authenticity of testing /inspection report & certificate, please contact us at telephone: (86-755) 8307 1443, or email: CN.Doccheck@sgs.com

ATTACHMENTS

PBBs/PBDEs Testing Flow Chart

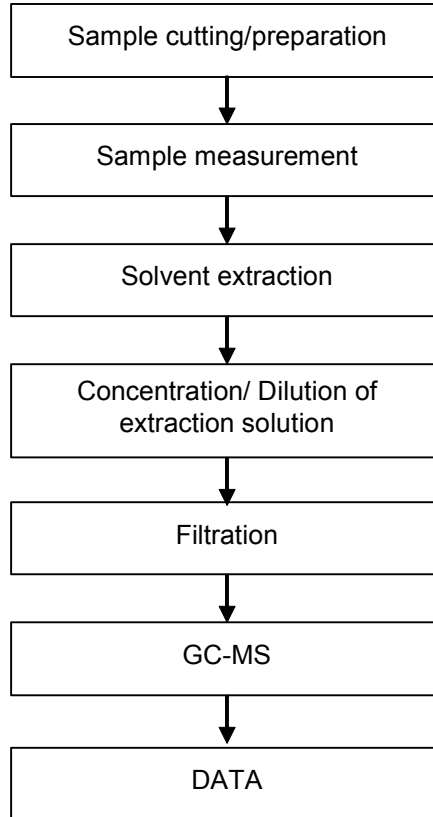

Unless otherwise agreed in writing, this document is issued by the Company subject to its General Conditions of Service printed overleaf, available on request or accessible at <http://www.sgs.com/en/Terms-and-Conditions.aspx> and, for electronic format documents, subject to Terms and Conditions for Electronic Documents at <http://www.sgs.com/en/Terms-and-Conditions/Terms-e-Documents.aspx>. Attention is drawn to the limitation of liability, indemnification and jurisdiction issues defined therein. Any holder of this document is advised that information contained hereon reflects the Company's findings at the time of its intervention only and within the limits of Client's instructions, if any. The Company's sole responsibility is to its Client and this document does not exonerate parties to a transaction from exercising all their rights and obligations under the transaction documents. This document cannot be reproduced except in full, without prior written approval of the Company. Any unauthorized alteration, forgery or falsification of the content or appearance of this document is unlawful and offenders may be prosecuted to the fullest extent of the law. Unless otherwise stated the results shown in this test report refer only to the sample(s) tested.

Attention: To check the authenticity of testing /inspection report & certificate, please contact us at telephone: (86-755) 8307 1443, or email: CN.Doccheck@sgs.com

ATTACHMENTS

Phthalates Testing Flow Chart

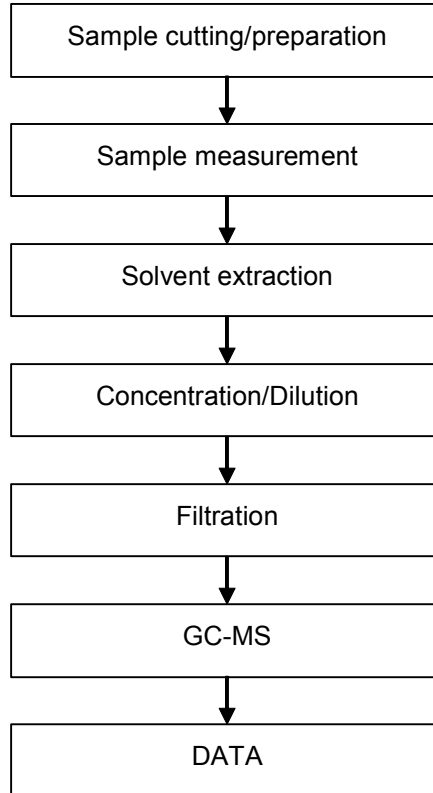

Unless otherwise agreed in writing, this document is issued by the Company subject to its General Conditions of Service printed overleaf, available on request or accessible at <http://www.sgs.com/en/Terms-and-Conditions.aspx> and, for electronic format documents, subject to Terms and Conditions for Electronic Documents at <http://www.sgs.com/en/Terms-and-Conditions/Terms-e-Documents.aspx>. Attention is drawn to the limitation of liability, indemnification and jurisdiction issues defined therein. Any holder of this document is advised that information contained hereon reflects the Company's findings at the time of its intervention only and within the limits of Client's instructions, if any. The Company's sole responsibility is to its Client and this document does not exonerate parties to a transaction from exercising all their rights and obligations under the transaction documents. This document cannot be reproduced except in full, without prior written approval of the Company. Any unauthorized alteration, forgery or falsification of the content or appearance of this document is unlawful and offenders may be prosecuted to the fullest extent of the law. Unless otherwise stated the results shown in this test report refer only to the sample(s) tested.

Attention: To check the authenticity of testing /inspection report & certificate, please contact us at telephone: (86-755) 8307 1443, or email: CN.Doccheck@sgs.com

ATTACHMENTS

Halogen Testing (oxygen bomb) Flow Chart

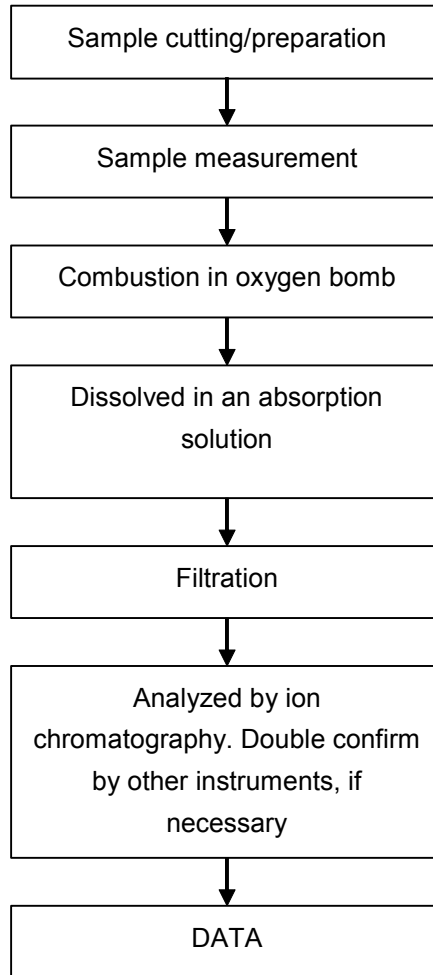

Unless otherwise agreed in writing, this document is issued by the Company subject to its General Conditions of Service printed overleaf, available on request or accessible at <http://www.sgs.com/en/Terms-and-Conditions.aspx> and, for electronic format documents, subject to Terms and Conditions for Electronic Documents at <http://www.sgs.com/en/Terms-and-Conditions/Terms-e-Documents.aspx>. Attention is drawn to the limitation of liability, indemnification and jurisdiction issues defined therein. Any holder of this document is advised that information contained hereon reflects the Company's findings at the time of its intervention only and within the limits of Client's instructions, if any. The Company's sole responsibility is to its Client and this document does not exonerate parties to a transaction from exercising all their rights and obligations under the transaction documents. This document cannot be reproduced except in full, without prior written approval of the Company. Any unauthorized alteration, forgery or falsification of the content or appearance of this document is unlawful and offenders may be prosecuted to the fullest extent of the law. Unless otherwise stated the results shown in this test report refer only to the sample(s) tested.

Attention: To check the authenticity of testing /inspection report & certificate, please contact us at telephone: (86-755) 8307 1443, or email: CN.Doccheck@sgs.com

ATTACHMENTS

HBCDD Testing Flow Chart

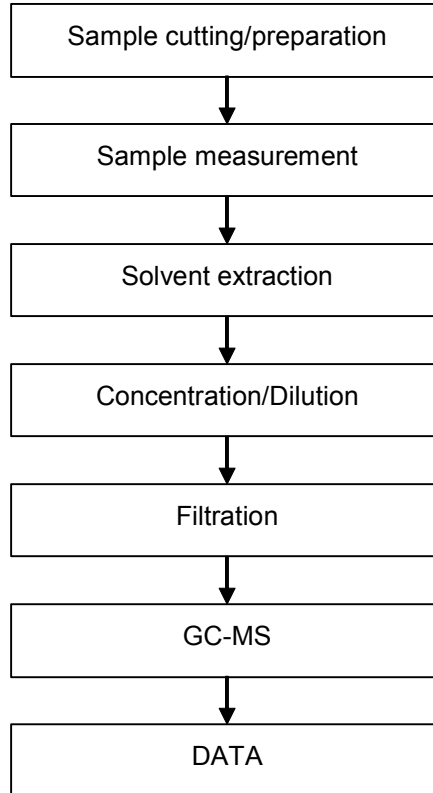

Unless otherwise agreed in writing, this document is issued by the Company subject to its General Conditions of Service printed overleaf, available on request or accessible at <http://www.sgs.com/en/Terms-and-Conditions.aspx> and, for electronic format documents, subject to Terms and Conditions for Electronic Documents at <http://www.sgs.com/en/Terms-and-Conditions/Terms-e-Document.aspx>. Attention is drawn to the limitation of liability, indemnification and jurisdiction issues defined therein. Any holder of this document is advised that information contained hereon reflects the Company's findings at the time of its intervention only and within the limits of Client's instructions, if any. The Company's sole responsibility is to its Client and this document does not exonerate parties to a transaction from exercising all their rights and obligations under the transaction documents. This document cannot be reproduced except in full, without prior written approval of the Company. Any unauthorized alteration, forgery or falsification of the content or appearance of this document is unlawful and offenders may be prosecuted to the fullest extent of the law. Unless otherwise stated the results shown in this test report refer only to the sample(s) tested.

Attention: To check the authenticity of testing /inspection report & certificate, please contact us at telephone: (86-755) 8307 1443, or email: CN.Doccheck@sgs.com

ATTACHMENTS

PFOS/PFOA Testing Flow Chart

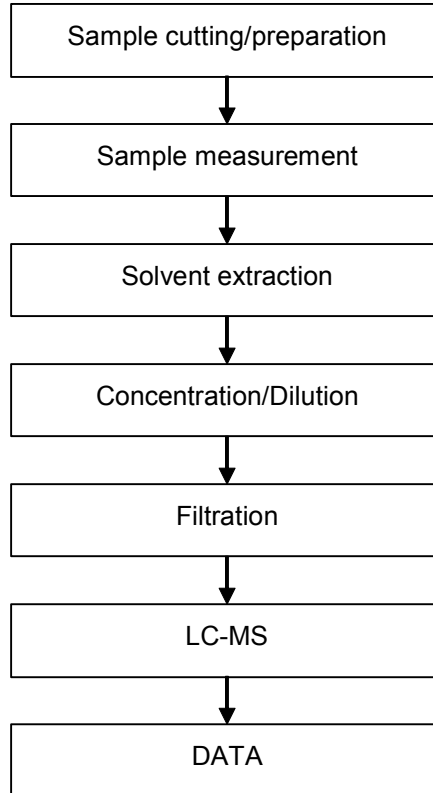

Unless otherwise agreed in writing, this document is issued by the Company subject to its General Conditions of Service printed overleaf, available on request or accessible at <http://www.sgs.com/en/Terms-and-Conditions.aspx> and, for electronic format documents, subject to Terms and Conditions for Electronic Documents at <http://www.sgs.com/en/Terms-and-Conditions/Terms-e-Document.aspx>. Attention is drawn to the limitation of liability, indemnification and jurisdiction issues defined therein. Any holder of this document is advised that information contained hereon reflects the Company's findings at the time of its intervention only and within the limits of Client's instructions, if any. The Company's sole responsibility is to its Client and this document does not exonerate parties to a transaction from exercising all their rights and obligations under the transaction documents. This document cannot be reproduced except in full, without prior written approval of the Company. Any unauthorized alteration, forgery or falsification of the content or appearance of this document is unlawful and offenders may be prosecuted to the fullest extent of the law. Unless otherwise stated the results shown in this test report refer only to the sample(s) tested.

Attention: To check the authenticity of testing /inspection report & certificate, please contact us at telephone: (86-755) 8307 1443, or email: CN.Doccheck@sgs.com

ATTACHMENTS

PAHs Testing Flow Chart

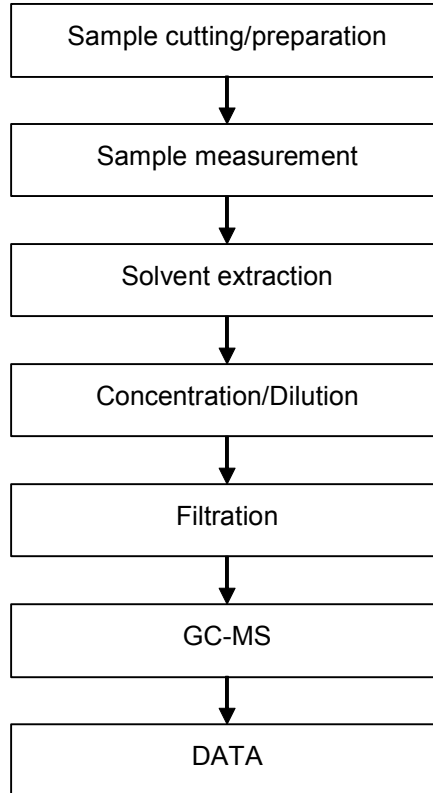

Unless otherwise agreed in writing, this document is issued by the Company subject to its General Conditions of Service printed overleaf, available on request or accessible at <http://www.sgs.com/en/Terms-and-Conditions.aspx> and, for electronic format documents, subject to Terms and Conditions for Electronic Documents at <http://www.sgs.com/en/Terms-and-Conditions/Terms-e-Documents.aspx>. Attention is drawn to the limitation of liability, indemnification and jurisdiction issues defined therein. Any holder of this document is advised that information contained hereon reflects the Company's findings at the time of its intervention only and within the limits of Client's instructions, if any. The Company's sole responsibility is to its Client and this document does not exonerate parties to a transaction from exercising all their rights and obligations under the transaction documents. This document cannot be reproduced except in full, without prior written approval of the Company. Any unauthorized alteration, forgery or falsification of the content or appearance of this document is unlawful and offenders may be prosecuted to the fullest extent of the law. Unless otherwise stated the results shown in this test report refer only to the sample(s) tested.

Attention: To check the authenticity of testing / inspection report & certificate, please contact us at telephone: (86-755) 8307 1443, or email: CN.Doccheck@sgs.com

ATTACHMENTS

Elements Testing Flow Chart

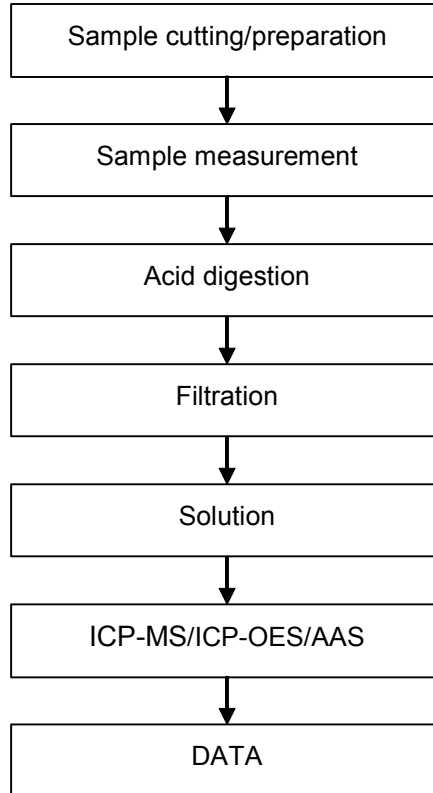

Unless otherwise agreed in writing, this document is issued by the Company subject to its General Conditions of Service printed overleaf, available on request or accessible at <http://www.sgs.com/en/Terms-and-Conditions.aspx> and, for electronic format documents, subject to Terms and Conditions for Electronic Documents at <http://www.sgs.com/en/Terms-and-Conditions/Terms-e-Documents.aspx>. Attention is drawn to the limitation of liability, indemnification and jurisdiction issues defined therein. Any holder of this document is advised that information contained hereon reflects the Company's findings at the time of its intervention only and within the limits of Client's instructions, if any. The Company's sole responsibility is to its Client and this document does not exonerate parties to a transaction from exercising all their rights and obligations under the transaction documents. This document cannot be reproduced except in full, without prior written approval of the Company. Any unauthorized alteration, forgery or falsification of the content or appearance of this document is unlawful and offenders may be prosecuted to the fullest extent of the law. Unless otherwise stated the results shown in this test report refer only to the sample(s) tested.

Attention: To check the authenticity of testing /inspection report & certificate, please contact us at telephone: (86-755) 8307 1443, or email: CN.Doccheck@sgs.com

ATTACHMENTS

BPA Testing Flow Chart

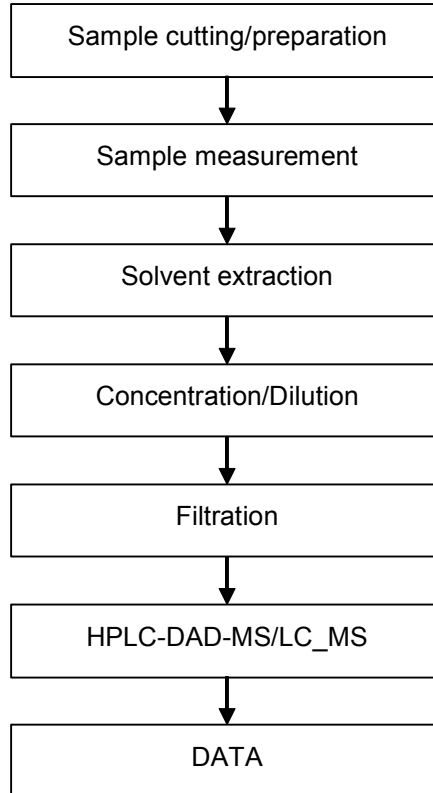

Unless otherwise agreed in writing, this document is issued by the Company subject to its General Conditions of Service printed overleaf, available on request or accessible at <http://www.sgs.com/en/Terms-and-Conditions.aspx> and, for electronic format documents, subject to Terms and Conditions for Electronic Documents at <http://www.sgs.com/en/Terms-and-Conditions/Terms-e-Document.aspx>. Attention is drawn to the limitation of liability, indemnification and jurisdiction issues defined therein. Any holder of this document is advised that information contained hereon reflects the Company's findings at the time of its intervention only and within the limits of Client's instructions, if any. The Company's sole responsibility is to its Client and this document does not exonerate parties to a transaction from exercising all their rights and obligations under the transaction documents. This document cannot be reproduced except in full, without prior written approval of the Company. Any unauthorized alteration, forgery or falsification of the content or appearance of this document is unlawful and offenders may be prosecuted to the fullest extent of the law. Unless otherwise stated the results shown in this test report refer only to the sample(s) tested.

Attention: To check the authenticity of testing /inspection report & certificate, please contact us at telephone: (86-755) 8307 1443, or email: CN.Doccheck@sgs.com

ATTACHMENTS

CoCl₂ Testing Flow Chart

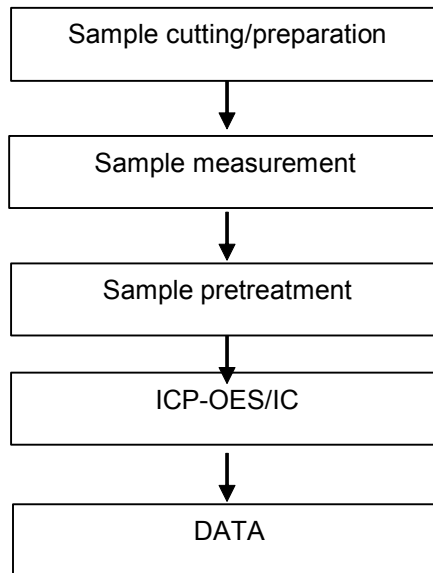

Unless otherwise agreed in writing, this document is issued by the Company subject to its General Conditions of Service printed overleaf, available on request or accessible at <http://www.sgs.com/en/Terms-and-Conditions.aspx> and, for electronic format documents, subject to Terms and Conditions for Electronic Documents at <http://www.sgs.com/en/Terms-and-Conditions/Terms-e-Documents.aspx>. Attention is drawn to the limitation of liability, indemnification and jurisdiction issues defined therein. Any holder of this document is advised that information contained hereon reflects the Company's findings at the time of its intervention only and within the limits of Client's instructions, if any. The Company's sole responsibility is to its Client and this document does not exonerate parties to a transaction from exercising all their rights and obligations under the transaction documents. This document cannot be reproduced except in full, without prior written approval of the Company. Any unauthorized alteration, forgery or falsification of the content or appearance of this document is unlawful and offenders may be prosecuted to the fullest extent of the law. Unless otherwise stated the results shown in this test report refer only to the sample(s) tested.

Attention: To check the authenticity of testing /inspection report & certificate, please contact us at telephone: (86-755) 8307 1443, or email: CN.Doccheck@sgs.com

ATTACHMENTS

Organotin Testing Flow Chart

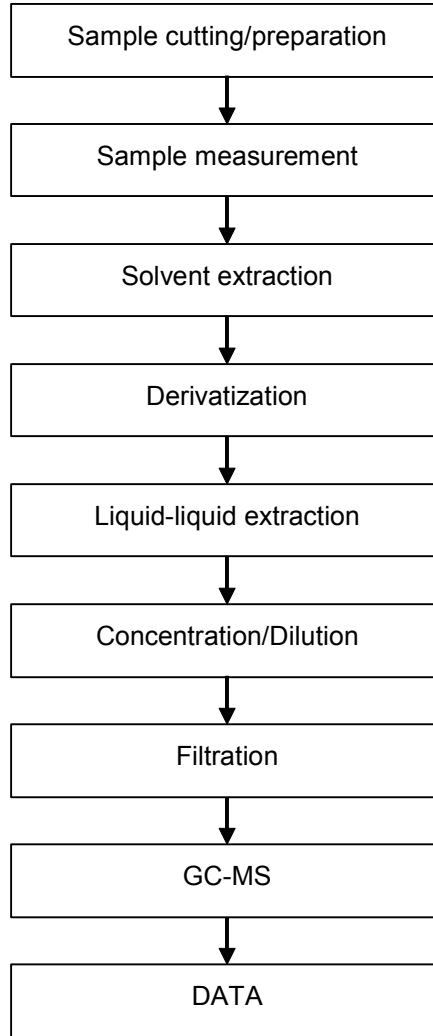

Unless otherwise agreed in writing, this document is issued by the Company subject to its General Conditions of Service printed overleaf, available on request or accessible at <http://www.sgs.com/en/Terms-and-Conditions.aspx> and, for electronic format documents, subject to Terms and Conditions for Electronic Documents at <http://www.sgs.com/en/Terms-and-Conditions/Terms-e-Documents.aspx>. Attention is drawn to the limitation of liability, indemnification and jurisdiction issues defined therein. Any holder of this document is advised that information contained hereon reflects the Company's findings at the time of its intervention only and within the limits of Client's instructions, if any. The Company's sole responsibility is to its Client and this document does not exonerate parties to a transaction from exercising all their rights and obligations under the transaction documents. This document cannot be reproduced except in full, without prior written approval of the Company. Any unauthorized alteration, forgery or falsification of the content or appearance of this document is unlawful and offenders may be prosecuted to the fullest extent of the law. Unless otherwise stated the results shown in this test report refer only to the sample(s) tested.

Attention: To check the authenticity of testing /inspection report & certificate, please contact us at telephone: (86-755) 8307 1443, or email: CN.Doccheck@sgs.com

ATTACHMENTS

PCB Testing Flow Chart

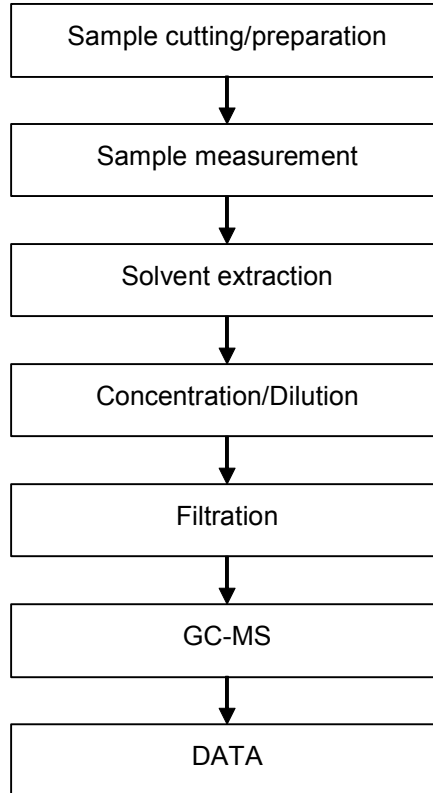

Unless otherwise agreed in writing, this document is issued by the Company subject to its General Conditions of Service printed overleaf, available on request or accessible at <http://www.sgs.com/en/Terms-and-Conditions.aspx> and, for electronic format documents, subject to Terms and Conditions for Electronic Documents at <http://www.sgs.com/en/Terms-and-Conditions/Terms-e-Documents.aspx>. Attention is drawn to the limitation of liability, indemnification and jurisdiction issues defined therein. Any holder of this document is advised that information contained hereon reflects the Company's findings at the time of its intervention only and within the limits of Client's instructions, if any. The Company's sole responsibility is to its Client and this document does not exonerate parties to a transaction from exercising all their rights and obligations under the transaction documents. This document cannot be reproduced except in full, without prior written approval of the Company. Any unauthorized alteration, forgery or falsification of the content or appearance of this document is unlawful and offenders may be prosecuted to the fullest extent of the law. Unless otherwise stated the results shown in this test report refer only to the sample(s) tested.

Attention: To check the authenticity of testing /inspection report & certificate, please contact us at telephone: (86-755) 8307 1443, or email: CN.Doccheck@sgs.com

ATTACHMENTS

PCN Testing Flow Chart

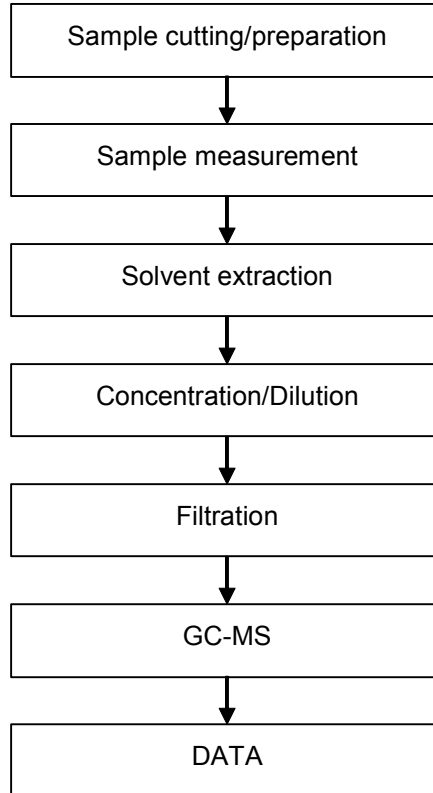

Unless otherwise agreed in writing, this document is issued by the Company subject to its General Conditions of Service printed overleaf, available on request or accessible at <http://www.sgs.com/en/Terms-and-Conditions.aspx> and, for electronic format documents, subject to Terms and Conditions for Electronic Documents at <http://www.sgs.com/en/Terms-and-Conditions/Terms-e-Documents.aspx>. Attention is drawn to the limitation of liability, indemnification and jurisdiction issues defined therein. Any holder of this document is advised that information contained hereon reflects the Company's findings at the time of its intervention only and within the limits of Client's instructions, if any. The Company's sole responsibility is to its Client and this document does not exonerate parties to a transaction from exercising all their rights and obligations under the transaction documents. This document cannot be reproduced except in full, without prior written approval of the Company. Any unauthorized alteration, forgery or falsification of the content or appearance of this document is unlawful and offenders may be prosecuted to the fullest extent of the law. Unless otherwise stated the results shown in this test report refer only to the sample(s) tested.

Attention: To check the authenticity of testing /inspection report & certificate, please contact us at telephone: (86-755) 8307 1443, or email: CN.Doccheck@sgs.com

ATTACHMENTS

PCT Testing Flow Chart

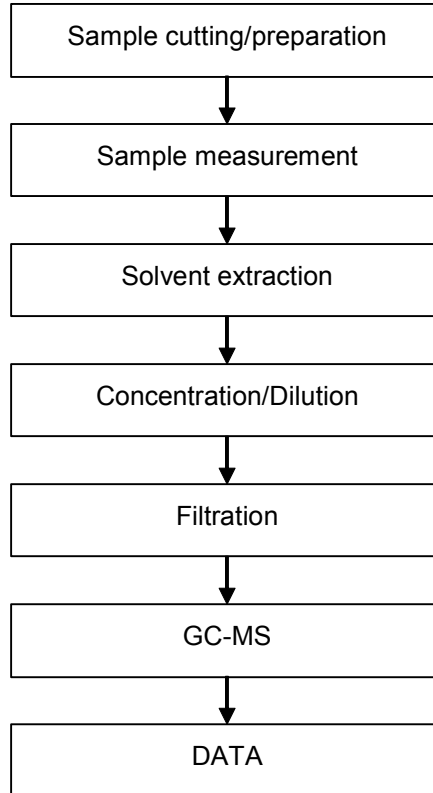

Unless otherwise agreed in writing, this document is issued by the Company subject to its General Conditions of Service printed overleaf, available on request or accessible at <http://www.sgs.com/en/Terms-and-Conditions.aspx> and, for electronic format documents, subject to Terms and Conditions for Electronic Documents at <http://www.sgs.com/en/Terms-and-Conditions/Terms-e-Document.aspx>. Attention is drawn to the limitation of liability, indemnification and jurisdiction issues defined therein. Any holder of this document is advised that information contained hereon reflects the Company's findings at the time of its intervention only and within the limits of Client's instructions, if any. The Company's sole responsibility is to its Client and this document does not exonerate parties to a transaction from exercising all their rights and obligations under the transaction documents. This document cannot be reproduced except in full, without prior written approval of the Company. Any unauthorized alteration, forgery or falsification of the content or appearance of this document is unlawful and offenders may be prosecuted to the fullest extent of the law. Unless otherwise stated the results shown in this test report refer only to the sample(s) tested.

Attention: To check the authenticity of testing /inspection report & certificate, please contact us at telephone: (86-755) 8307 1443, or email: CN.Doccheck@sgs.com

ATTACHMENTS

PVC Testing Flow Chart

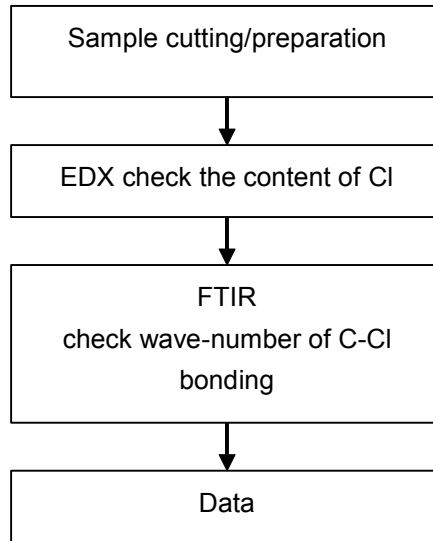

Unless otherwise agreed in writing, this document is issued by the Company subject to its General Conditions of Service printed overleaf, available on request or accessible at <http://www.sgs.com/en/Terms-and-Conditions.aspx> and, for electronic format documents, subject to Terms and Conditions for Electronic Documents at <http://www.sgs.com/en/Terms-and-Conditions/Terms-e-Documents.aspx>. Attention is drawn to the limitation of liability, indemnification and jurisdiction issues defined therein. Any holder of this document is advised that information contained hereon reflects the Company's findings at the time of its intervention only and within the limits of Client's instructions, if any. The Company's sole responsibility is to its Client and this document does not exonerate parties to a transaction from exercising all their rights and obligations under the transaction documents. This document cannot be reproduced except in full, without prior written approval of the Company. Any unauthorized alteration, forgery or falsification of the content or appearance of this document is unlawful and offenders may be prosecuted to the fullest extent of the law. Unless otherwise stated the results shown in this test report refer only to the sample(s) tested.

Attention: To check the authenticity of testing /inspection report & certificate, please contact us at telephone: (86-755) 8307 1443, or email: CN.Doccheck@sgs.com

ATTACHMENTS

Chlorinated Paraffin Testing Flow Chart

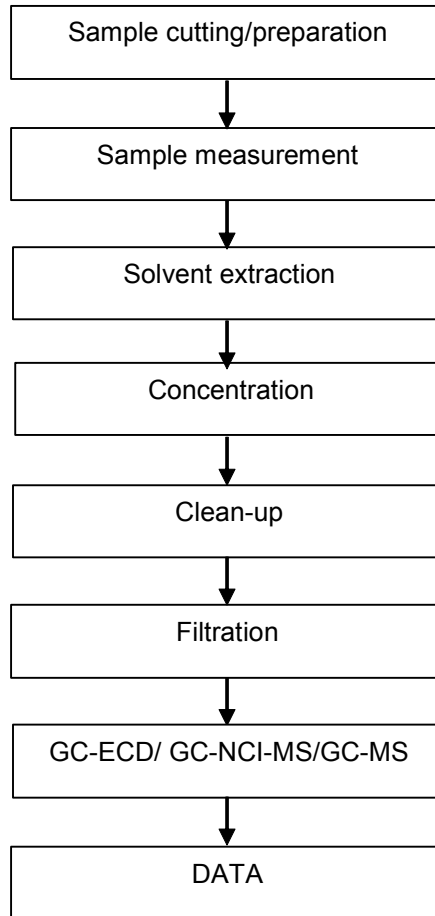

Unless otherwise agreed in writing, this document is issued by the Company subject to its General Conditions of Service printed overleaf, available on request or accessible at <http://www.sgs.com/en/Terms-and-Conditions.aspx> and, for electronic format documents, subject to Terms and Conditions for Electronic Documents at <http://www.sgs.com/en/Terms-and-Conditions/Terms-e-Documents.aspx>. Attention is drawn to the limitation of liability, indemnification and jurisdiction issues defined therein. Any holder of this document is advised that information contained hereon reflects the Company's findings at the time of its intervention only and within the limits of Client's instructions, if any. The Company's sole responsibility is to its Client and this document does not exonerate parties to a transaction from exercising all their rights and obligations under the transaction documents. This document cannot be reproduced except in full, without prior written approval of the Company. Any unauthorized alteration, forgery or falsification of the content or appearance of this document is unlawful and offenders may be prosecuted to the fullest extent of the law. Unless otherwise stated the results shown in this test report refer only to the sample(s) tested.

Attention: To check the authenticity of testing /inspection report & certificate, please contact us at telephone: (86-755) 8307 1443, or email: CN.Doccheck@sgs.com

ATTACHMENTS

Benzotriazole Testing Flow Chart

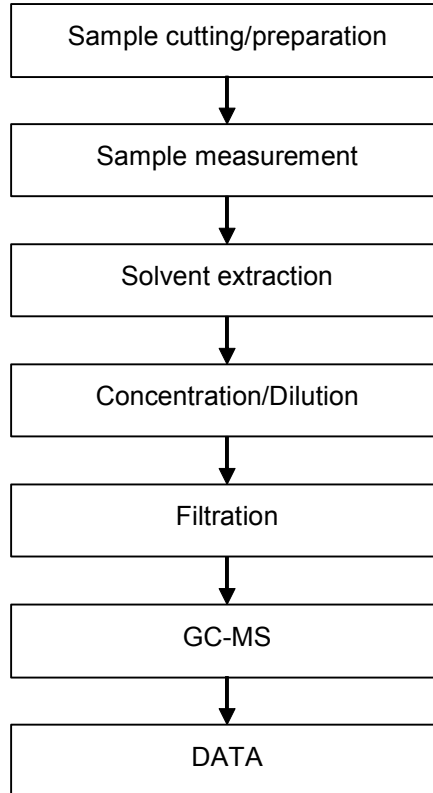

Unless otherwise agreed in writing, this document is issued by the Company subject to its General Conditions of Service printed overleaf, available on request or accessible at <http://www.sgs.com/en/Terms-and-Conditions.aspx> and, for electronic format documents, subject to Terms and Conditions for Electronic Documents at <http://www.sgs.com/en/Terms-and-Conditions/Terms-e-Documents.aspx>. Attention is drawn to the limitation of liability, indemnification and jurisdiction issues defined therein. Any holder of this document is advised that information contained hereon reflects the Company's findings at the time of its intervention only and within the limits of Client's instructions, if any. The Company's sole responsibility is to its Client and this document does not exonerate parties to a transaction from exercising all their rights and obligations under the transaction documents. This document cannot be reproduced except in full, without prior written approval of the Company. Any unauthorized alteration, forgery or falsification of the content or appearance of this document is unlawful and offenders may be prosecuted to the fullest extent of the law. Unless otherwise stated the results shown in this test report refer only to the sample(s) tested.

Attention: To check the authenticity of testing /inspection report & certificate, please contact us at telephone: (86-755) 8307 1443, or email: CN.Doccheck@sgs.com

ATTACHMENTS

DMF (N, N-dimethylformamide) Testing Flow Chart

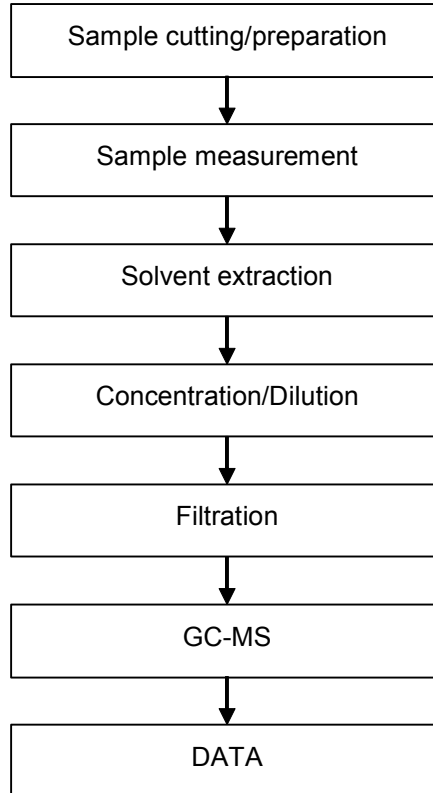

Unless otherwise agreed in writing, this document is issued by the Company subject to its General Conditions of Service printed overleaf, available on request or accessible at <http://www.sgs.com/en/Terms-and-Conditions.aspx> and, for electronic format documents, subject to Terms and Conditions for Electronic Documents at <http://www.sgs.com/en/Terms-and-Conditions/Terms-e-Document.aspx>. Attention is drawn to the limitation of liability, indemnification and jurisdiction issues defined therein. Any holder of this document is advised that information contained hereon reflects the Company's findings at the time of its intervention only and within the limits of Client's instructions, if any. The Company's sole responsibility is to its Client and this document does not exonerate parties to a transaction from exercising all their rights and obligations under the transaction documents. This document cannot be reproduced except in full, without prior written approval of the Company. Any unauthorized alteration, forgery or falsification of the content or appearance of this document is unlawful and offenders may be prosecuted to the fullest extent of the law. Unless otherwise stated the results shown in this test report refer only to the sample(s) tested.

Attention: To check the authenticity of testing /inspection report & certificate, please contact us at telephone: (86-755) 8307 1443, or email: CN.Doccheck@sgs.com

ATTACHMENTS

DMF (Dimethyl fumarate) Testing Flow Chart

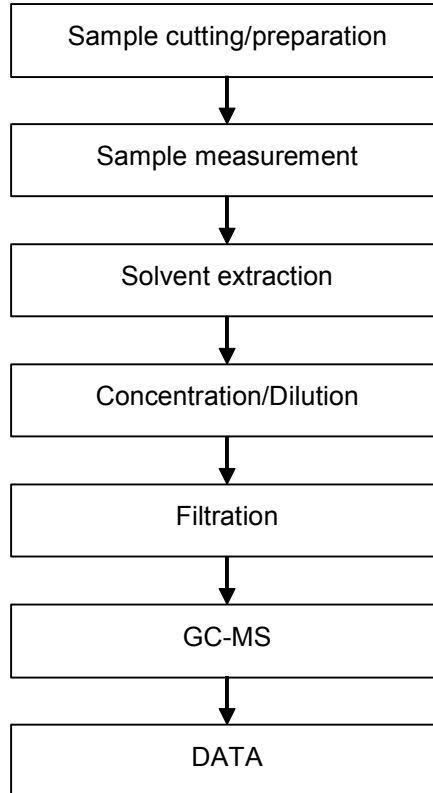

Unless otherwise agreed in writing, this document is issued by the Company subject to its General Conditions of Service printed overleaf, available on request or accessible at <http://www.sgs.com/en/Terms-and-Conditions.aspx> and, for electronic format documents, subject to Terms and Conditions for Electronic Documents at <http://www.sgs.com/en/Terms-and-Conditions/Terms-e-Documents.aspx>. Attention is drawn to the limitation of liability, indemnification and jurisdiction issues defined therein. Any holder of this document is advised that information contained hereon reflects the Company's findings at the time of its intervention only and within the limits of Client's instructions, if any. The Company's sole responsibility is to its Client and this document does not exonerate parties to a transaction from exercising all their rights and obligations under the transaction documents. This document cannot be reproduced except in full, without prior written approval of the Company. Any unauthorized alteration, forgery or falsification of the content or appearance of this document is unlawful and offenders may be prosecuted to the fullest extent of the law. Unless otherwise stated the results shown in this test report refer only to the sample(s) tested.

Attention: To check the authenticity of testing /inspection report & certificate, please contact us at telephone: (86-755) 8307 1443, or email: CN.Doccheck@sgs.com

Sample photo:

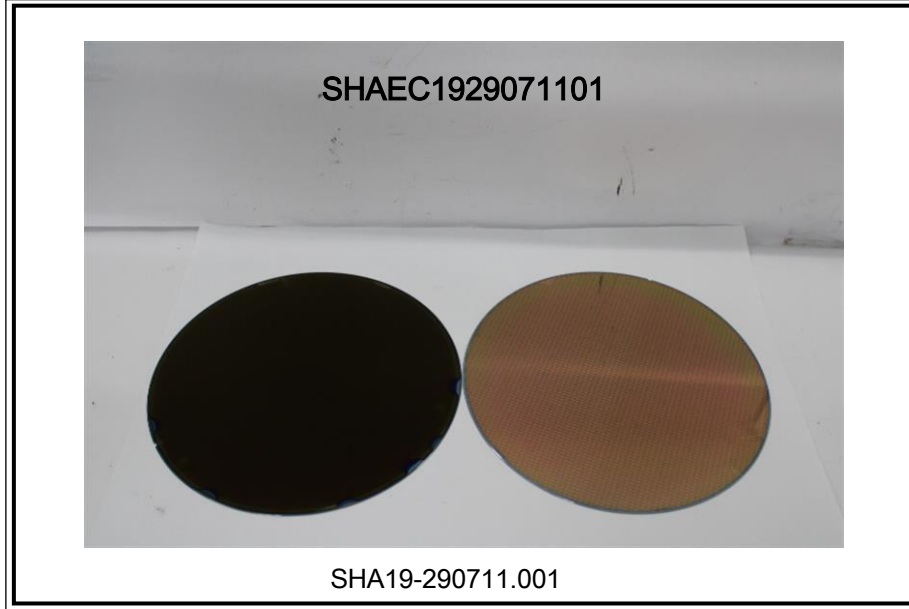

SGS authenticate the photo on original report only

*** End of Report ***



Unless otherwise agreed in writing, this document is issued by the Company subject to its General Conditions of Service printed overleaf, available on request or accessible at <http://www.sgs.com/en/Terms-and-Conditions.aspx> and, for electronic format documents, subject to Terms and Conditions for Electronic Documents at <http://www.sgs.com/en/Terms-and-Conditions/Terms-e-Documents.aspx>. Attention is drawn to the limitation of liability, indemnification and jurisdiction issues defined therein. Any holder of this document is advised that information contained hereon reflects the Company's findings at the time of its intervention only and within the limits of Client's instructions, if any. The Company's sole responsibility is to its Client and this document does not exonerate parties to a transaction from exercising all their rights and obligations under the transaction documents. This document cannot be reproduced except in full, without prior written approval of the Company. Any unauthorized alteration, forgery or falsification of the content or appearance of this document is unlawful and offenders may be prosecuted to the fullest extent of the law. Unless otherwise stated the results shown in this test report refer only to the sample(s) tested.

Attention: To check the authenticity of testing / inspection report & certificate, please contact us at telephone: (86-755) 8307 1443, or email: CN.Doccheck@sgs.com